

## Übergabedokumentation / Documentation

Anlagenbeschreibung / Description

---

Anlagenart / Type of plant

---

Hersteller / Manufacturer

---

Seriennummer / Serial number

---

Datum der Inbetriebnahme / Commissioning date

---

Aufstellort / Site of installation

---

Verwendete Steuerung / Control unit

---

Zusatzkomponenten / Additional components

### Funktionsprüfung / Functional test

Sicherheitssensoren reagieren auf Betätigung / Safety sensors response to actuation

ok

Sicherheitssensoren reagieren auf Zuleitungsunterbrechung /  
Safety sensors response to supply line interruption

ok

---

Name der ausführenden Firma / Installing company

---

Name des Installateurs / Installer

---

Datum / Date

---

Unterschrift / Signature

## **Table of Contents**

<b>1</b>	<b>Generals notes</b>	<b>5</b>
1.1	Explanation of symbols	5
1.2	Terms and Abbreviations	6
1.3	Safety regulations / Protective measures	7
<b>2</b>	<b>Product description</b>	<b>8</b>
2.1	Intended use	9
2.2	Example of use	9
2.2.1	Barrier system with 1x control unit & 1x sensor unit	9
2.2.2	Barrier system with 1x control unit & 2x sensor unit	10
2.2.3	Barrier system with 2x control units & 2x sensor units	10
2.3	General overview	11
2.3.1	LISENS scan CA-B set 2	11
2.4	Type code sensor unit	11
2.5	Device overview Sensor Unit	12
2.5.1	Display elements	12
2.5.2	Electrical connection	12
2.6	Product key Control Unit	14
2.7	Device overview Control Unit	15
2.7.1	Display elements	15
2.7.2	Electrical connection	15
<b>3</b>	<b>Installation</b>	<b>16</b>
3.1	Package contents	16
3.1.1	Partially assembled contents	16
3.1.2	Further components for mounting with hinged arm	16
3.2	Installation specifications for barriers with skirt and/or pendulum support	17
3.2.1	Barrier systems over 3m with skirt	17
3.2.2	Barrier systems over 3m with skirt and pendulum support	17
3.2.3	Barrier systems under 3m with skirt	17
3.3	Installation specifications and possible installation errors	18
3.3.1	Installation height of the sensor unit	18
3.3.2	Influence of soil conditions	18
3.3.3	Positioning of the Sensor	19
3.3.4	Axis depictions	19
3.3.5	Obstacles in the sensor unit's field of view	20
3.4	Sensor positioning	20
3.4.1	Mounting side of the sensor	20
3.4.2	Horizontal viewing angles	21
3.4.3	Angle alignment to the ground (inclination)	21
3.4.4	Definition of zones	21
3.5	Mounting the sensor with articulated arm	22
3.6	Tools	23
3.7	Mounting the sensor in the customer's housing	23
3.8	Installation	24
<b>4</b>	<b>Connection and function description</b>	<b>25</b>
4.1	Electrical connection	25
4.2	Connection of the power supply	25
4.3	Sensor connection	25
4.4	Connecting safety outputs	26

# LISENS scan

## OPERATING INSTRUCTION

4.4.1	Relay safety output (observe variant type code)	26
4.4.2	FSS safety output (note variant type code)	26
4.4.3	Safety output 8k2 – simulation (note variant type code)	27
4.5	Connection of comfort outputs	27
4.5.1	AUX relay safety zone (SZ)	27
4.5.2	Relay for comfort zone	28
4.6	Display functions	28
4.7	„Factory reset“ button	29
5	Web-Interface	29
5.1	Connection to WiFi	29
5.2	Login screen	30
5.3	System information	30
5.4	Menu bar (User)	31
5.5	Menu > Configuration	31
5.5.1	Digital water level	32
5.5.2	Configuration of the switching outputs	33
5.5.3	Configuration of barrier parameters	35
5.5.4	Configuration of sensor position	36
5.5.5	Configuration of zone(s)	37
5.5.6	Display of sensor and zone positions	38
5.5.7	Firmware update	39
5.6	Menu > WiFi settings	40
5.7	Menu > Change user credentials	41
5.8	Virtual loops	41
6	Commissioning and function testing	42
6.1	Functionality test	42
7	Error diagnosis and troubleshooting	43
7.1	General errors	44
7.2	Data transmission between Control Unit and Sensor Unit interrupted	44
7.3	No objects available	44
7.4	Disruption due to environmental influences	44
7.5	Mechanical failure	44
8	Maintenance and servicing	44
9	Decommissioning and disposal	44
10	Technical specifications	45
11	Declaration of conformity	47
12	FAQ	48
13	Notes on WIFI connection and login	50
	Notes on parameter settings	51

## 1 Generals notes

This document is the original operating manual for the „LISENS scan“ safety radar for use on barrier and gate systems.

This operating manual contains information on installation, operation, maintenance, servicing, decommissioning and disposal. It is specifically intended for technical installers and service technicians.

In the following description, the variants are generally referred to as „safety radar“ or „LISENS scan“, even if this is only a device with PL3.

These operating instructions apply to the following items:

Article number	Designation	From version
2302-0300	LISENS scan CA-B-Set 1	V1.3
2302-0320	LISENS scan CUC2-2BA	V1.2
2302-0340	LISENS scan CUC2-2BC1	V1.3
2302-0310	LISENS scan SUC1-1240E	V1.2
2302-0330	LISENS scan SUC2-1240E	V1.2
2302-0350	LISENS scan CC1-B-Set 1	V1.4
2302-0311	LISENS scan SUC3-1240E Erw.-Set A	V1.2
2302-0321	LISENS scan CUC2-2BA	V1.2
2302-0331	LISENS scan SUC2-1240E Erw.-Set A	V1.2
2302-0301	LISENS scan CA-B-Set 2	V1.3
2302-0351	LISENS scan CC1-B-Set 2	V1.4
2302-0341	LISENS scan CUC2-2BC1	V1.3

All previous editions of this document are no longer valid for the current hardware and software of the device. Technical and operational changes to the products and devices listed in this documentation are subject to change without notice. No liability can be accepted for errors or misprints.

The safety radar may only be commissioned by certified electricians who are familiar with the safety standards for electrical drive and automation technology. Detailed knowledge of the safety radar and the necessary safety measures for barriers is essential. Therefore, please read these operating instructions carefully! The safety instructions must be observed without exception!

### 1.1 Explanation of symbols



**DANGER!**

This indicates a high-risk hazard which, if not avoided, will result in death or serious injury. The following safety instructions must be observed to avoid serious personal injury.



**WARNING!**

This indicates a hazard with a medium degree of risk which, if not avoided, could result in death or serious injury. The following safety instructions must be observed to prevent personal injury.



**CAUTION!**

This indicates a hazard with a low risk level which, if not avoided, could result in minor or moderate injury. The following safety instructions must be observed to prevent personal injury or damage to property.



**Note**

Further information or references to other documentation are provided.

### 1.2 Terms and Abbreviations

AC .....	Alternating Current
CU .....	Control Unit
DC .....	Direct Current
DIN .....	German Institute for Standardization
EMC .....	Electromagnetic compatibility
EN .....	European standard
FAQ.....	Frequently Asked Questions
FOV.....	Field Of View refers to the area in the angle of view of an optical device within which events or changes can be detected and recorded.
GND .....	Ground
GUI.....	Graphical User Interface
HW .....	Hardware
IP .....	Intrusion Protection
ISO .....	International Organisation for Standardization
LED .....	Light Emitting Diode
RCS.....	Radar Cross Section
RPD.....	Radar Protective Device
SU .....	Sensor Unit
Tolerance zone.....	Area outside the protective field with limited detection capability
TÜV.....	Technical Inspection Association
URL.....	Uniform Resource Locator
VCC .....	Voltage of Common Collector

## 1.3 Safety regulations / Protective measures



### **WARNING!**

Before operating the sensor system, read these operating instructions carefully.

To ensure proper functioning and safety, the instructions in this manual must be followed. Failure to observe the warnings may result in personal injury and property damage. The manufacturer is not liable for damage caused by failure to observe the instructions or by deliberate misuse.

Manufacturers and users of the installation/machine on which the safety radar is used are responsible for coordinating and complying with all applicable safety regulations and rules on their own responsibility.

In conjunction with the higher-level control system, the safety radar guarantees functional safety, but not the safety of the entire system/machine. Before using the protective device, it is therefore necessary to carry out a safety assessment of the entire system/machine in accordance with the Machinery Directive 2006/42/EC or the relevant product standard.

The operating instructions must be available at all times at the place of use of the safety radar. They must be read thoroughly and applied by every person who is responsible for operating, maintaining or servicing the protective device.

The safety radar may only be installed and commissioned by qualified personnel who are familiar with these operating instructions and the applicable regulations on occupational safety and accident prevention. The instructions in this manual must be observed and complied with at all times.

Electrical work may only be carried out by qualified electricians. Electrical engineering and trade association safety regulations must be observed. When work is carried out on the system, it must be disconnected from the power supply, checked to ensure that it is free of voltage and secured against being switched back on.

If the connections of the safety radar are supplied with a hazardous voltage from an external source, this must also be safely switched off when working on the device.

Sufficient protective circuitry must be provided for capacitive and inductive loads at the connections.

During assembly, installation, commissioning and operation, it must be ensured that no interference with the safety radar can occur from other radar sources. Do not install in the immediate vicinity of strong heat sources.

The safety radar does not contain any components that require maintenance by the user. Unauthorised modifications or repairs to the switchgear will void any warranty and liability on the part of the manufacturer.



### **WARNING!**

The Comfort version can be used as a D-device in accordance with EN 12453 and does not meet the functional safety requirements of EN ISO 13849. When using the Comfort version, the functional safety of the system must be ensured by other measures.

# LISENS scan

## OPERATING INSTRUCTION



### WARNING!

To ensure that the safety system complies with the DIN EN 12453 standard „Safety in use of power-operated doors and gates“, the system must be checked by qualified personnel at appropriate intervals to ensure that it is functioning correctly. A new inspection is mandatory after six months at the latest. The inspection must be documented in a manner that can be traced at any time.



### Note

Checking the zones with test body A as specified in standard DIN EN 12453 is not suitable due to the current lack of technical specifications for test bodies for the measuring principle of a radar sensor and may result in test body A being transmitted through and not detected.

## 2 Product description

The safety radar is used to detect a collision between a barrier and an obstacle in advance. If the safety radar is installed correctly, it is not necessary to attach contact strips to the barrier.

When installing a Comfort version, a C-device (power cut-off) must always be present.

The compact security radar is designed for outdoor use and can be operated with a low voltage of 10V to 30V DC or 14V to 26,4V AC.

The Comfort version serves as an auxiliary device for the control function and must not perform any safety functions.

The monitoring status of the safety radar and the applied operating voltage are indicated by LEDs. If an error message is present, all outputs are inactive.

A user interface for a mobile device is available via a WiFi connection for configuring and controlling the sensor unit's field of view. The Internet browser on the mobile device is used for this purpose. A special application for the mobile device is not required.

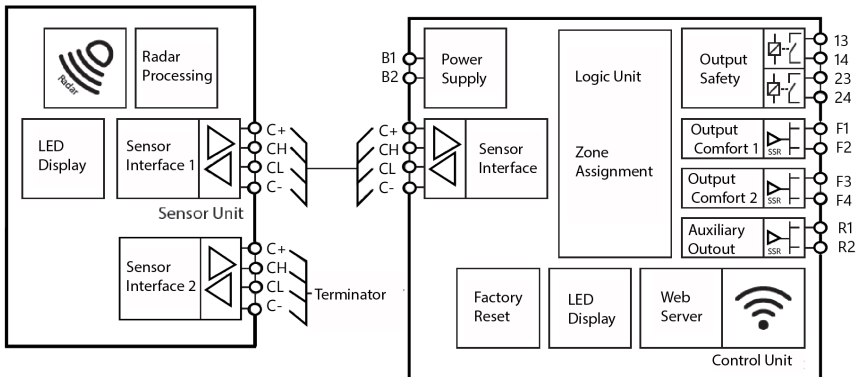

Functional diagram of a control unit with a sensor unit

## 2.1 Intended use

The safety radar can only fulfil its safety-related task if it is used as intended.

The intended use of the safety radar is for use on barrier systems to detect obstacles during dangerous movements.

In addition to replacing light barriers, the safety radar can perform the convenience function of a loop detector. These additional functions are not safety functions and do not comply with the EN 12978 standard.

The Comfort version can be used as a D-device in accordance with DIN EN 12453 and does not meet the functional safety requirements of EN ISO 13849. It can be used as a replacement for a light barrier if it is installed in such a way that it covers the required monitoring area in accordance with the standard. When using the Comfort version, the functional safety of the system must be ensured by other measures (e.g. power cut-off by safety contact strips as a C device in accordance with DIN EN 12453).

The safety radar must not be used for machine monitoring in production processes.

Any other use or use beyond this is not in accordance with the intended purpose. The manufacturer accepts no liability for damage resulting from use that is not in accordance with the intended purpose. This includes, among other things, installing the sensor unit in customer-specific housings and areas that have not been approved in writing by the manufacturer, or installing it behind protective covers.

Use in special applications requires approval from the manufacturer.



### CAUTION!

The device can be used in residential and industrial environments up to an altitude of 2000 metres above sea level. The device must not be operated in areas subject to extreme temperature fluctuations.

## 2.2 Example of use

### 2.2.1 Barrier system with 1x control unit & 1x sensor unit

These application examples show safety monitoring at a barrier system in various situations (see image descriptions). The arrangement of the individual components depends on the respective barrier design and the structural conditions.

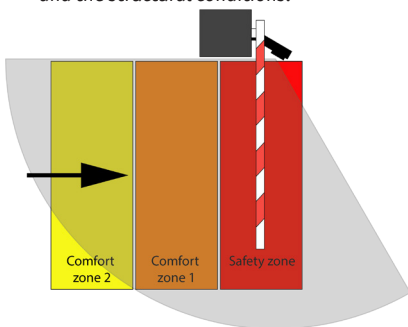

LISENS scan sensor unit on barrier for one-way access

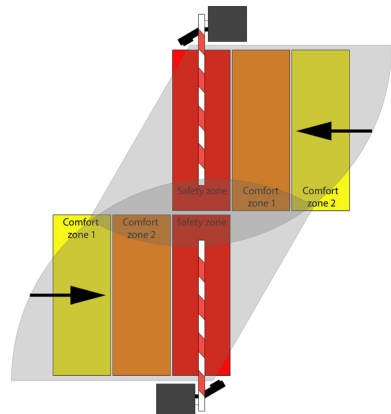

LISENS scan sensor unit at barriers for entry and exit

# LISENS scan

## OPERATING INSTRUCTION

### 2.2.2 Barrier system with 1x control unit & 2x sensor unit

A pendulum support or a hanging grid on the barrier affects the field of view of the safety radar. The use of two sensor units is recommended, especially when using a hanging grid.

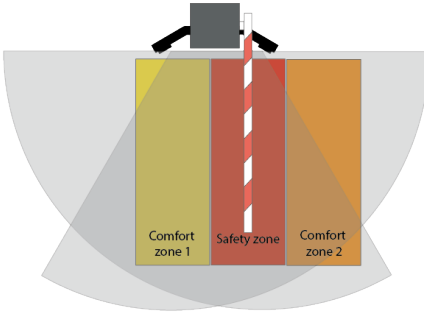

Two LISENS scan sensor units on barrier for two-sided access

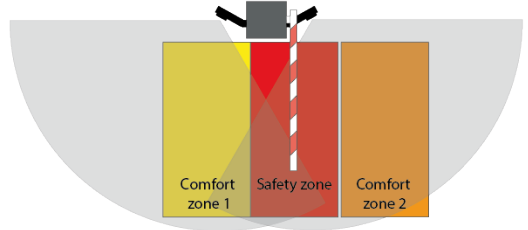

Two LISENS scan sensor units on barrier with skirt for two-sided access

### 2.2.3 Barrier system with 2x control units & 2x sensor units

A pendulum support or a skirt on the barrier affects the field of view of the safety radar. The use of two sensor units is recommended, especially when using a skirt. By installing a second control unit, two comfort zones can be set up on each side of the barrier. Each sensor unit must be connected to an control unit.

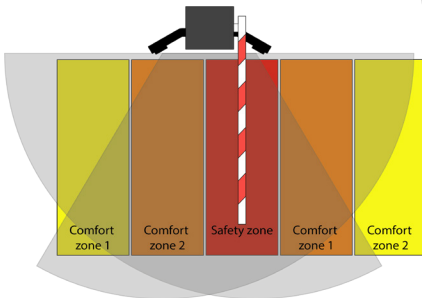

Two LISENS scan systems on barrier for two-sided access



Two LISENS scan systems on barrier with skirt for two-sided access

## 2.3 General overview

### 2.3.1 LISENS scan CA-B set 2

(see chapter 3)

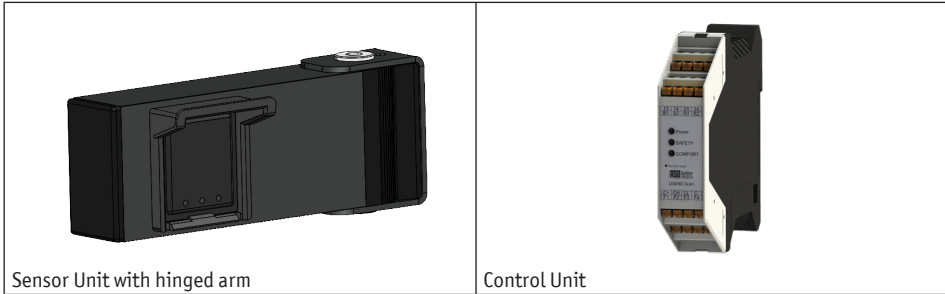

The safety radar consists of the control unit and up to six sensor units. The system and its functions are configured and checked using the web interface. Communication between the sensor unit and the control unit takes place via a bus connection. A terminating resistor is connected to the last sensor unit.

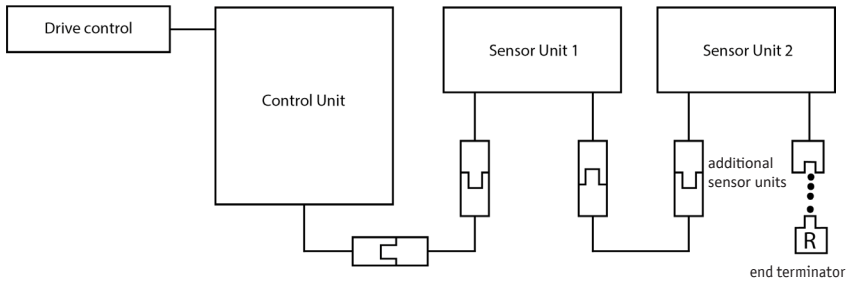

Overall view of LISENS scan with two connected sensors and a terminating resistor

During installation, the short four-wire cable with the M8 socket with snap-in technology must be connected to the corresponding connections on the control unit for communication with the sensor unit. The connections between the sensor unit and the control unit are made using four-pin M8 cables with plugs and couplings using snap-in technology. The terminating resistor on the last sensor unit consists of a four-pin M8 plug, also constructed using snap-in technology.

## 2.4 Type code sensor unit

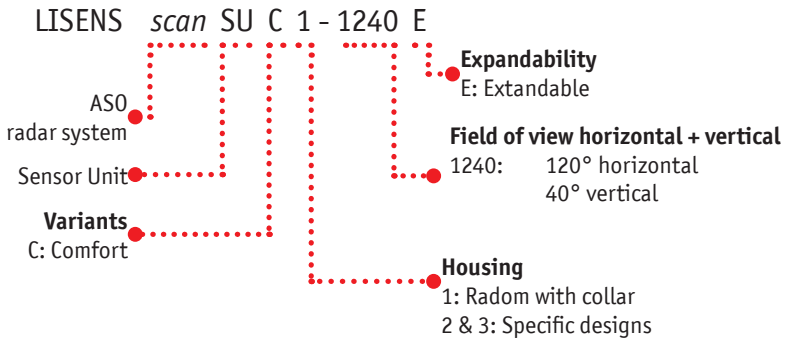

# LISENS scan

## OPERATING INSTRUCTION

### 2.5 Device overview Sensor Unit

LISENS scan SUC1-1240E

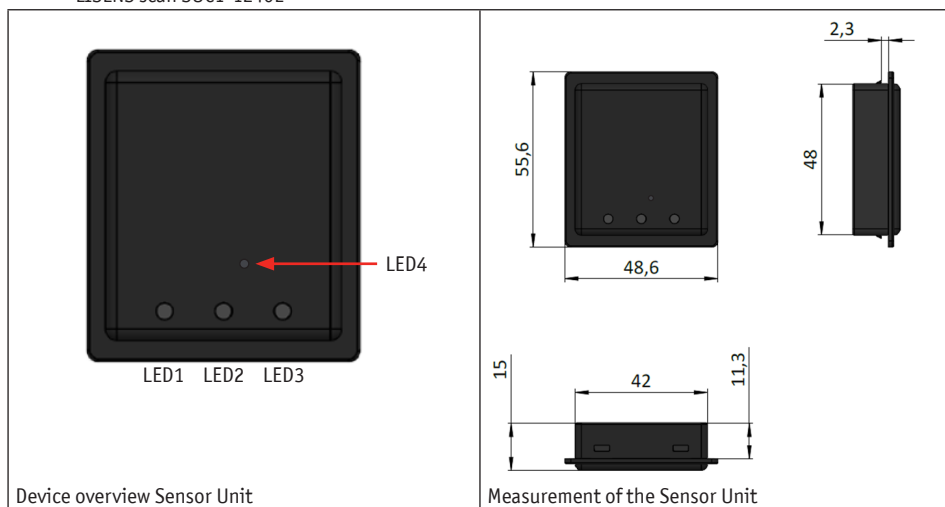

#### 2.5.1 Display elements

LED1	Power	Operating status display
LED2	SAFETY	Safety zone signal status
LED3	COMFORT	Comfort zone signal status
LED4	VOLTAGE	Internal voltage display (glows faintly through the housing material)

When used correctly, the same messages are displayed as on the Control Unit.

#### 2.5.2 Electrical connection

There are two cables on the back with an M8 plug and an M8 coupling with snap-in technology. The M8 plug is intended for connection to the control unit or the preceding sensor. The M8 coupling is intended for connection to the subsequent sensor unit or for the terminating resistor.



#### Note

If several sensors are connected, the control unit may only be started for sensor programming with one sensor unit including a connected M8 terminating resistor. For connecting additional sensors, see section 2.5.3 of these instructions.

#### 2.5.3 Connecting one or more sensor units to a control unit

After successfully connecting a control unit to a sensor unit, including the connected M8 terminator, the device must be started up with the permissible operating voltage. You will then be taken to the user interface.

Here, you can start the „Add sensors“ function in the „Configuration“ menu.

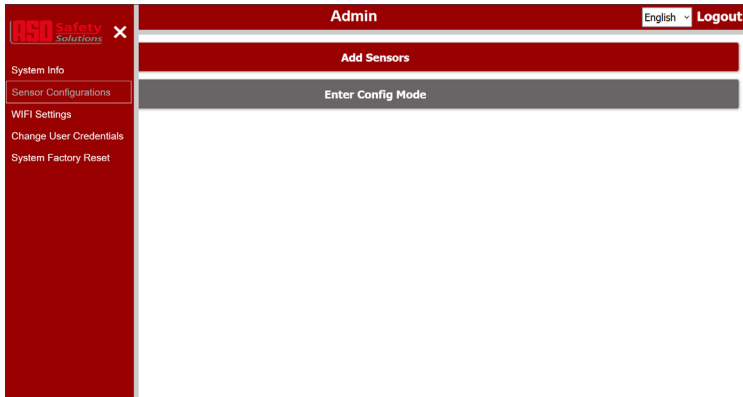

When this function is started, the message „Searching for sensor(s)“ appears.

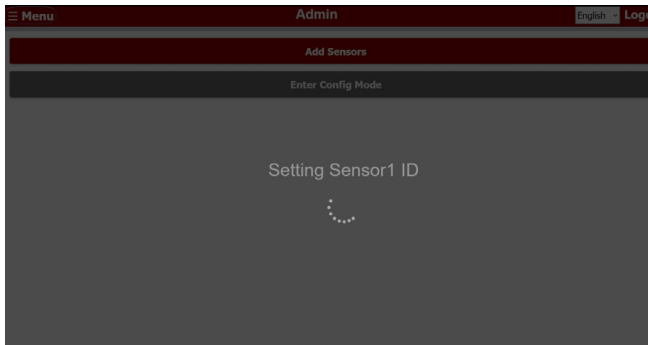

The sensor unit that is already connected is added automatically and receives its own ID (No. 1). After the message „Sensor ID successfully set“ appears, confirm this message with „OK“.

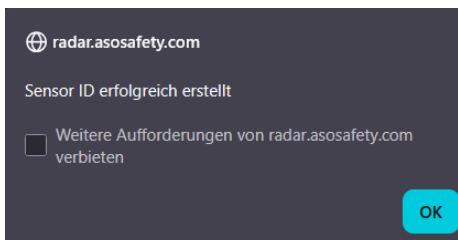

# LISENS scan

## OPERATING INSTRUCTION

Now, with the system running, a new sensor unit can be added in sequence (max. 6 sensors per control unit).

To do this, proceed as follows:

1. Connect the new sensor unit to the primary sensor using the appropriate connection cable instead of the M8 terminator (reverse polarity protected).
  2. The M8 terminator must be attached to the open cable of the newly connected sensor unit so that the system recognises that this sensor has been added.
  3. If connected correctly, the sensor is recognised automatically and receives its „ID“.
- When the process is complete, the message „Sensor ID successfully set“ is displayed.

Once this is confirmed with „OK“, additional sensors can be added (repeat steps 1-3 for each addition sensor) or the process can be terminated (by pressing the „Exit“ button).

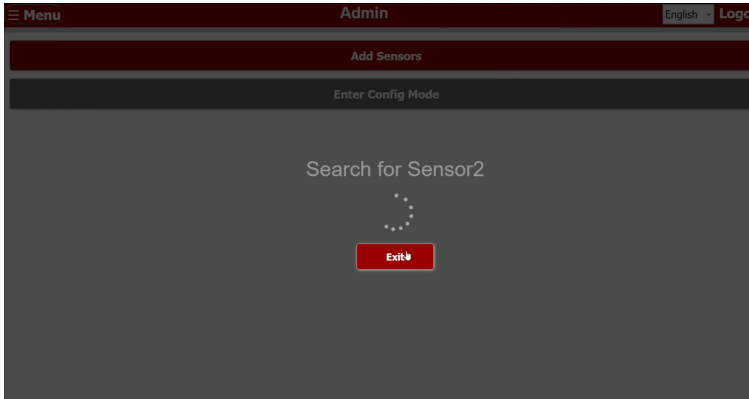

When you have successfully added the maximum number of 6 sensors, the system will automatically exit the function. Otherwise, you will need to exit this function manually.

Once you have exited the function, you can start configuring the system.

See 5.5 for more information.

## 2.6 Product key Control Unit

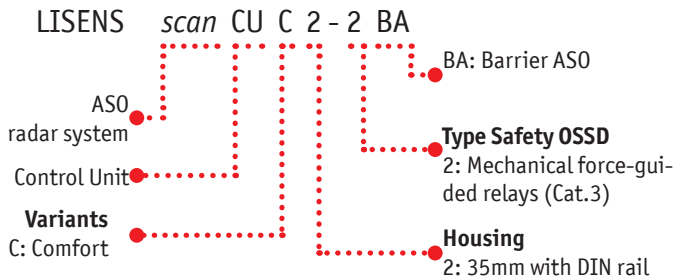

## 2.7 Device overview Control Unit

LISENS scan CUC2-2BA

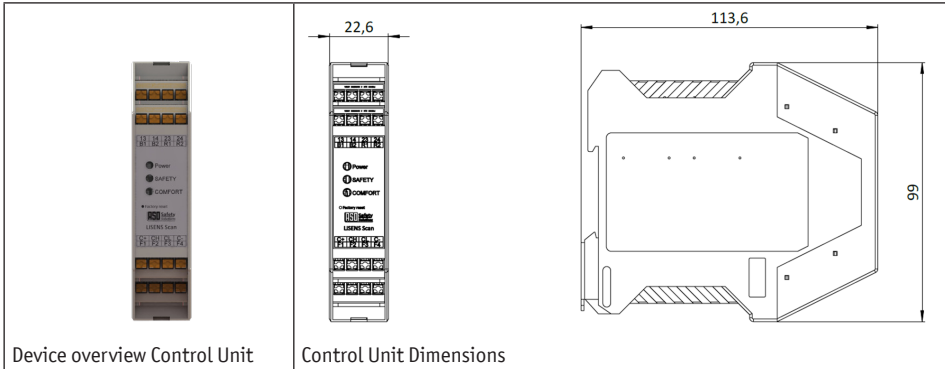

Device overview Control Unit

Control Unit Dimensions

### 2.7.1 Display elements

Power	Power Operating status display
SAFETY	Safety zone signal status
COMFORT	Comfort zone signal status

When connected correctly, the same messages are displayed as on the sensor unit.

### 2.7.2 Electrical connection

13	Safety relay 1 Contact 13 (Safety Zone)
14	Safety relay 1 Contact 14 (Safety Zone)
23	Safety relay 2 Contact 23 (Safety Zone)
24	Safety relay 2 Contact 24 (Safety Zone)
B1	Power Input 10 - 30V DC 5,9W / 14-26,4V AC 9VA
B2	Power Input 10 - 30V DC 5,9W / 14-26,4V AC 9VA
R1	Aux Relay Contact R1 (Safety Zone)
R2	Aux Relay Contact R2 (Safety Zone)
C+	Sensor power 12V output
CH	Sensor high
CL	Sensor low
C-	Sensor power GND output
F1	Solid state relay 1 Contact F1 (Comfort Zone)
F2	Solid state relay 1 Contact F2 (Comfort Zone)
F3	Solid state relay 2 Contact F3 (Comfort Zone)
F4	Solid state relay 2 Contact F4 (Comfort Zone)

### 3 Installation

#### 3.1 Package contents

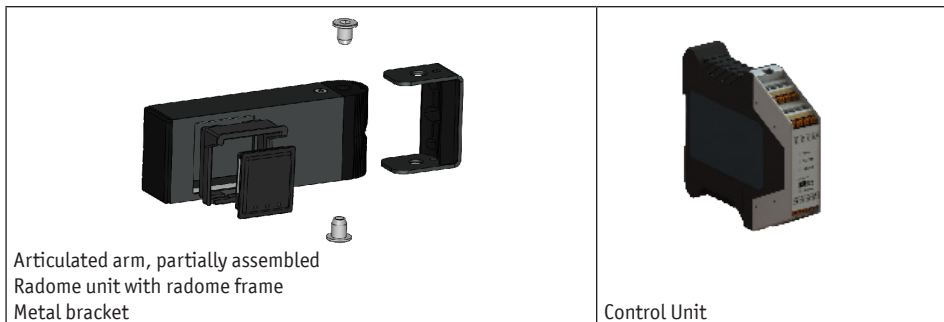

Articulated arm, partially assembled  
Radome unit with radome frame  
Metal bracket

Control Unit

#### 3.1.1 Partially assembled contents

Quantity	Item no.	Description
1	2302-0100	Aluminium hollow profile
2	2302-0140	Countersunk screw for thermoplastics 5 x 16 mm (self-tapping)
1	2302-0030	Radius plug
1	2302-0190	Metal bracket
1	2302-0040	Inlay metal bracket
1		Inlay mounting bracket
2	2302-0150	Cylinder screw, steel, galvanised, M5 x 8 mm
1	2302-0210	Terminating resistor (BUS termination M8 snap 4-pin)
2	2302-0210	8k2 THT resistor
1		Control unit

#### 3.1.2 Further components for mounting with hinged arm

Quantity	Item no.	Description
1	2302-0110	Lamella plug
2	2302-0120	Sleeve nut, flat head, hexagon socket
1		Form A threaded bolt, galvanised, M8 x 65 mm
1	2302-0020	Radome unit with surround
1		Radome frame 0°
2	2302-0220	PA6 round rod 5 mm
2		Galvanised cylinder screw M5 x 10 mm
2	2302-0170	Galvanised washer, inner diameter 5.3 mm
2		Galvanised hexagon nut, M5

### 3.2 Installation specifications for barriers with skirt and/or pendulum support

#### 3.2.1 Barrier systems over 3m with skirt

For barriers with skirt, it is important that the sensor unit is installed at least 15cm to the side of the skirt. The sensor unit can be aligned from 0° (parallel to the barrier boom) to 30° (turned away from the barrier boom). If the sensor unit is turned towards the skirt, smooth operation cannot be guaranteed.

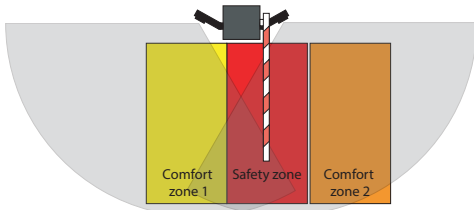

Two LISENS scan sensor units on a barrier with a skirt >3m in length for two-sided access (30° sensor unit alignment)

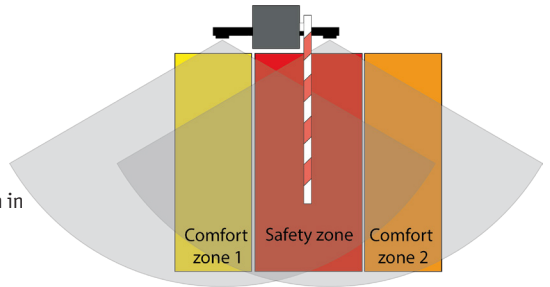

Two LISENS scan sensor units on a barrier with a skirt >3m in length for two-sided access (0° sensor unit alignment)

#### 3.2.2 Barrier systems over 3m with skirt and pendulum support

For barrier systems with a total length of over 3m that have skirt and a pendulum support, only the „Skirt“ function needs to be activated (click the checkbox). The „Pendulum support“ function must not be activated in parallel with the „Skirt“ function.

#### 3.2.3 Barrier systems under 3m with skirt

The „Skirt“ function is not possible for barriers with a barrier length including skirt of less than 3m. In this case, the sensor unit must be rotated (Z-axis) so that the field of view does not extend into the skirt. Therefore, two sensor units are recommended for this case (one on each side).

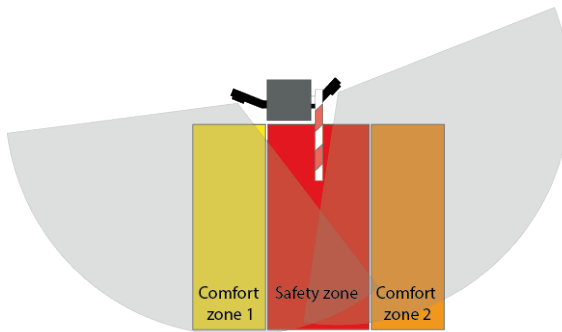

Two LISENS scan sensor units on a barrier with a skirt <3m in length for two-sided access



### CAUTION!

Observe the protective zone at the end of the barrier. The fields of view for the protective zones of the individual sensor units must overlap behind the end of the barrier to prevent unwanted and unprotected entry into the safety zone.



### Note

Object detection and, above all, object classification as „vehicles“ in comfort zones may be impaired by the skirt, depending on the alignment of the sensor unit. This may result in objects being detected or classified correctly only at a later point in time. Late or incorrect classification is more likely, especially for object detection and classification for comfort zones that are located behind the skirt as seen from the sensor. If the sensor unit is to monitor the side of the skirt that is not the installation side of the sensor unit, it is recommended to place the comfort zones for the barrier opening/closing command close to the barrier/safety zone, to keep them as small as possible and to configure the switching outputs so that each object can activate the zones.

Due to the varying structural conditions, use in this manner is at your own risk. The manufacturer accepts no liability for material defects resulting in property damage and/or the non-permanent operation of the barrier.

## 3.3 Installation specifications and possible installation errors

The following basic aspects must be taken into account during installation:

- Avoid strong vibrations
- Do not cover the radar window
- Avoid moving objects and other radar sources in front of the radar window

### 3.3.1 Installation height of the sensor unit

The sensor unit must be mounted on the barrier housing between 55cm and 100cm above the ground and at least 15cm below the barrier boom. If the distances are not maintained, the detection of objects and obstacles may be impeded and lead to misinterpretations.

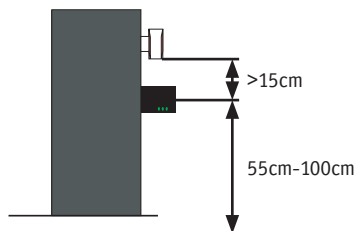

### 3.3.2 Influence of soil conditions

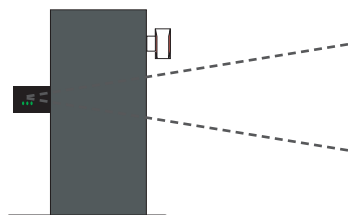

Slope in the sensor unit's field of view

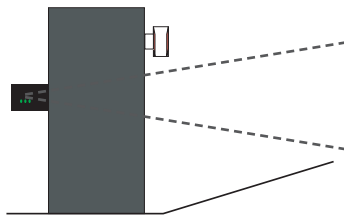

Incline in the sensor unit's field of view

Inclines or slopes in the sensor unit's field view (e.g. at entrances and exits to car parks) can reduce the functional performance and detectability of objects and obstacles.

If there is a slope in the sensor unit's field of view, the vehicle will leave the detection area too early or reach it too late, depending on the direction of movement.

If there is an incline in the sensor unit's field of view, the vehicle will leave the detection area too late or reach it too early, depending on the direction of movement.

The sensor unit's detection range is not affected by slopes or inclines in the field of view.

### 3.3.3 Positioning of the Sensor

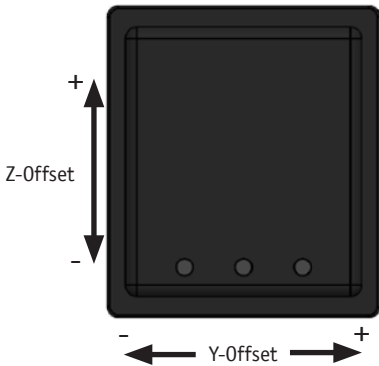

Positioning of the sensor unit Front view

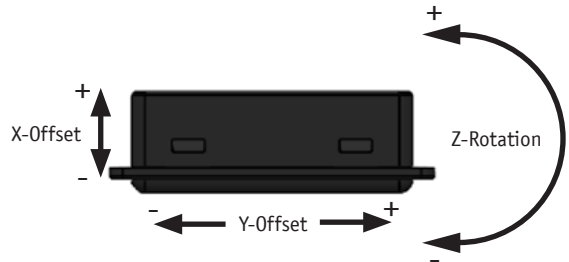

Positioning of the sensor unit Top view

### 3.3.4 Axis depictions

LISENS scan sensor unit on the housing  
„Top view“

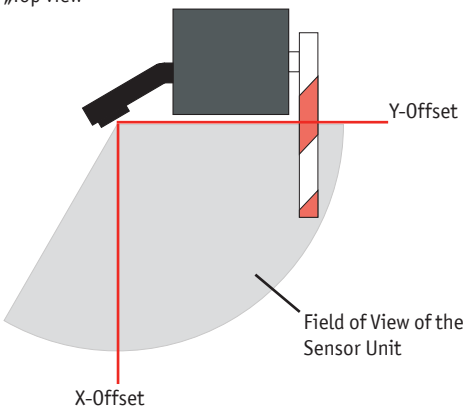

LISENS scan sensor unit on the housing  
„Front view“

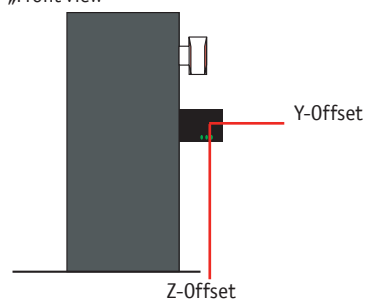

# LISENS scan

## OPERATING INSTRUCTION

LISENS scan sensor unit on the housing  
„Side view“

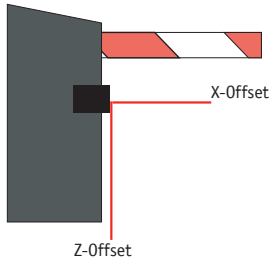

### 3.3.5 Obstacles in the sensor unit's field of view

The sensor unit's field of view must be clear for the entire detection range. Obstacles in the field of view (e.g. bollards as impact protection) can restrict the detectability of objects and impair functional behaviour.

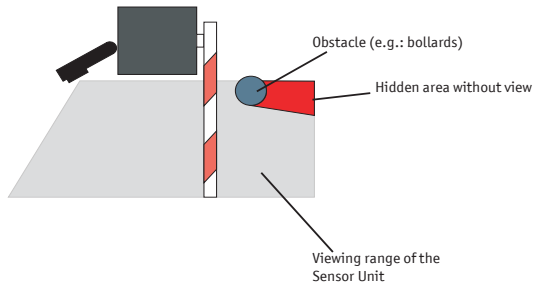

## 3.4 Sensor positioning

### 3.4.1 Mounting side of the sensor

Depending on the mounting side on the barrier housing and the use of the boom, the Sensor Unit must be installed as follows.

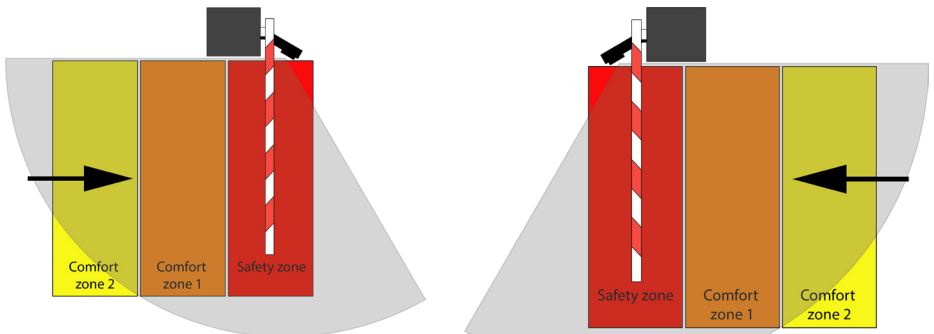

Left mounting side

Right mounting side

### 3.4.2 Horizontal viewing angles

On the horizontal plane of the sensor unit's detection range, a maximum of  $\pm 30^\circ$  can be used for the safety zone. The safety zone is limited to  $\pm 30^\circ$ , especially when using skirt on barriers.

The articulated arm allows the horizontal viewing angle of the sensor unit to be rotated by  $\pm 45^\circ$ . A larger rotation angle of up to  $\pm 45^\circ$  can be achieved with a customised articulated arm.

A horizontal viewing angle of up to  $\pm 45^\circ$  can be displayed in the Live Image menu on the user interface. The angle  $0^\circ$  corresponds to the viewing direction of the sensor unit along the barrier boom.



#### Note

Although angles  $>30^\circ$  can be achieved, the safety function can only be guaranteed at  $\pm 30^\circ$ .

### 3.4.3 Angle alignment to the ground (inclination)

When the sensor unit is aligned parallel to the ground, the angle is  $0^\circ$ .

A radome mount with a  $15^\circ$  inclination can be used for a customer-specific solution.

However, the detection range of the sensor unit is then limited to 8m. The manufacturer cannot accept any liability for the limited detection capability.

In addition, the functionality of comfort features and stability in adverse weather conditions may be reduced.

### 3.4.4 Definition of zones

When using barriers with pendulum supports or skirt, the detection capability of the safety radar may be limited.

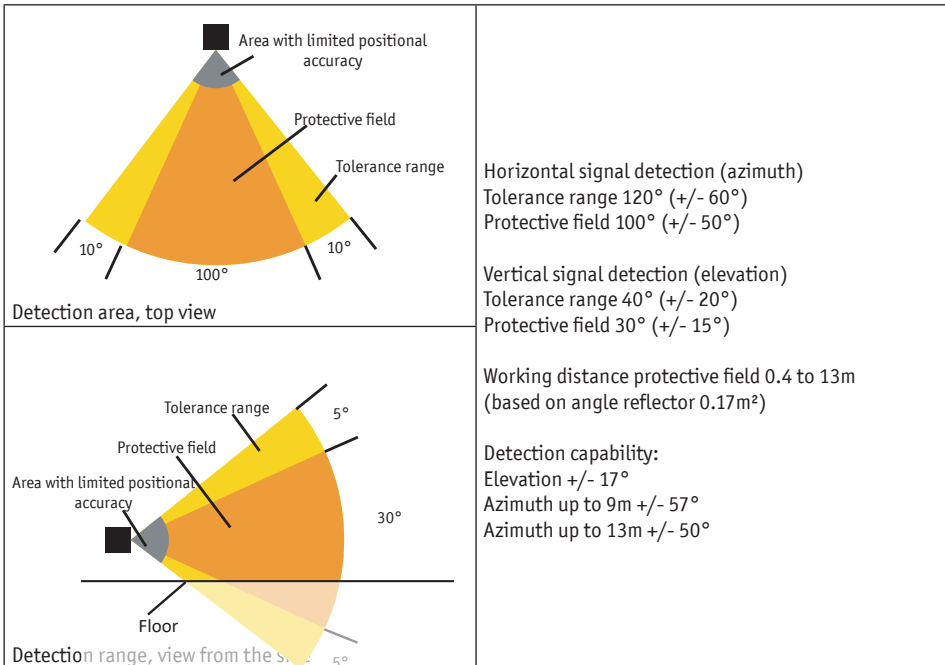

# LISENS scan

## OPERATING INSTRUCTION

Ensure that the safety zone is within the protective field or detection zone of the sensor unit. The safety zone must not extend beyond the protective field or detection zone, as detection of objects there cannot be guaranteed.

The comfort zones, which do not represent safety functions, can also be located outside the protective field or detection zone, but here too, detection of objects is not 100% guaranteed.

### 3.5 Mounting the sensor with articulated arm

The articulated arm is delivered partially assembled. Depending on the mounting position, the sensor unit is inserted into the articulated arm in a mirror-inverted position.

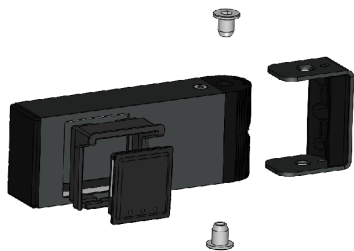

View for mounting the sensor with articulated arm, mounting side on the right

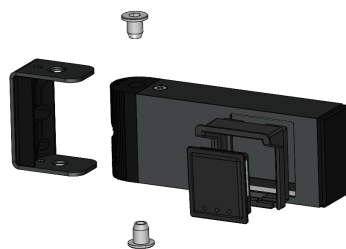

View for mounting the sensor with articulated arm, mounting side on the left

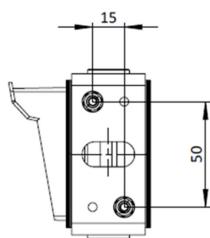

Dimensions of articulated arm

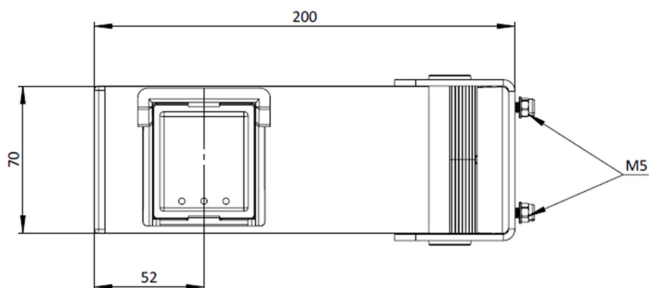

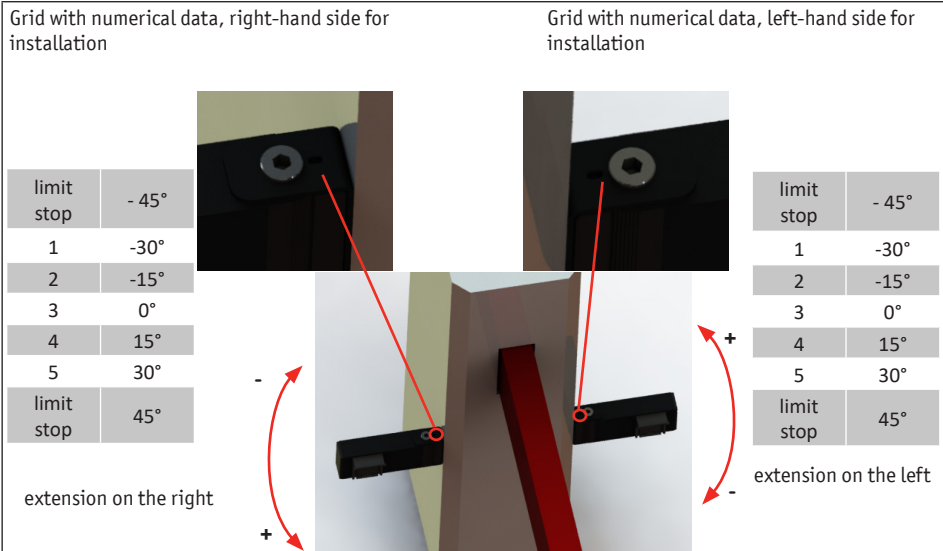

The viewing angle of the sensor unit (Z-axis) can be adjusted by up to  $\pm 45^\circ$  using the articulated arm. The angle is adjusted by  $5^\circ$  with each detent step. The angle set is displayed as a number in a window on the bracket for the articulated arm, depending on the mounting side.

See the illustration above.

At the end positions of the detent settings,  $\pm 45^\circ$  is reached without a number being visible in the window of the bracket. The safety function can only be guaranteed within the viewing angle of the sensor unit of  $\pm 30^\circ$ .

### 3.6 Tools

The following tools and aids are recommended for assembly:

- Cordless screwdriver
- Drilling and cutting oil
- M5 tap
- 4.2mm drill bit for thread tapping; 6mm if using washers + nuts
- Drill bits (cable feed-through): 1x cable -> 10mm, 2x cables -> 12mm
- Allen key size 5
- Torx screwdriver T25
- Spirit level

### 3.7 Mounting the sensor in the customer's housing

It is possible to install the sensor unit with the protective cover in a customer-specific housing. Please note that the safety function can only be guaranteed within the opening angle of  $\pm 30^\circ$  from the sensor unit. The opening angle for the safety function can be rotated to a maximum of  $\pm 45^\circ$ . The display on the live image in the configuration menu is limited to  $\pm 45^\circ$ .

For the dimensions of the radar, refer to the 'Sensor unit dimensions' graphic in chapter „2.4 Type code sensor unit“.

# LISENS scan

## OPERATING INSTRUCTION

### 3.8 Installation



#### DANGER!

When installing the sensor, ensure that the sensor has a clear view of the safety zone and that the safety zone fits within the protective field or detection zone. Obstacles such as street lamps, deflectors or railings located in the sensor's field of vision can prevent objects/persons behind such obstacles from being detected correctly, which can lead to dangerous situations.

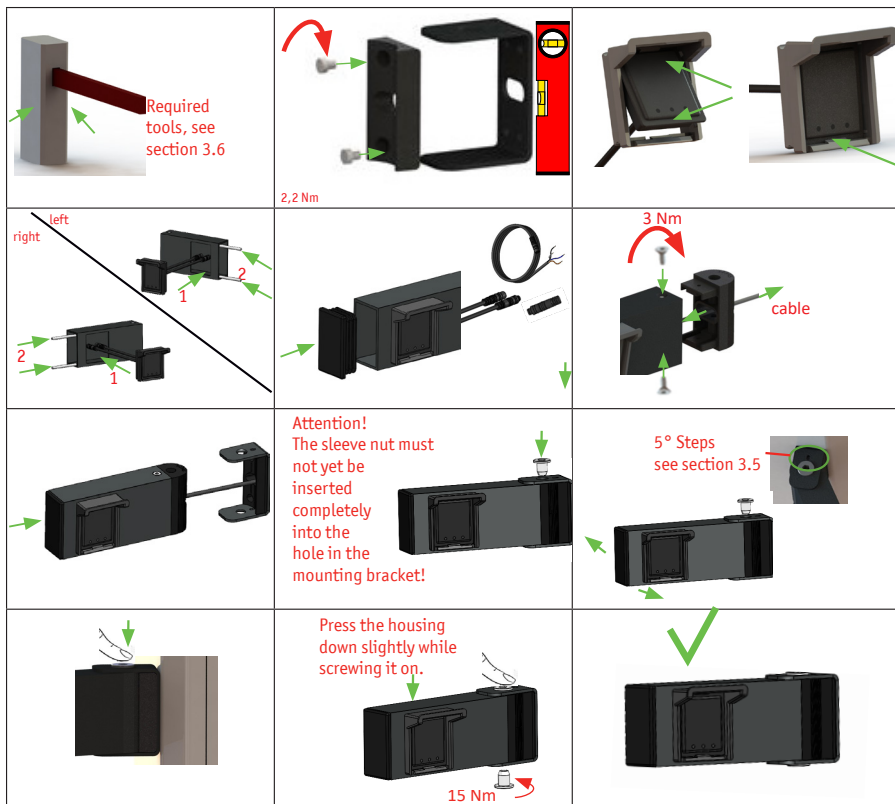

For the electrical connection, the control unit must be placed on a top-hat rail inside the barrier housing and pressed down. The control unit will audibly click into place.

The control unit must be installed in a control cabinet with protection class IP54 or better (e.g. the barrier housing). Now all electrical connections can be made as described in the following section „Connection and function description“ and the device can be put into operation.

Each additional sensor must be installed according to the same procedure. In addition, the sensors must be connected to each other with a suitable connection cable.

## 4 Connection and function description



### DANGER!

The safety radar may only be commissioned by qualified electricians with recognised training who are familiar with the safety standards for electrical drive and automation technology.

### 4.1 Electrical connection

The following connection work must be carried out with particular care in accordance with the specifications in this manual.

Connecting the wires of the connection cable to the wrong terminals can destroy the safety radar. The limit values for the supply voltage and switching capacity specified in Chapter 10 „Technical Specifications“ must be observed.



### DANGER!

The signal cable must not be laid parallel to the motor cable or other power cables. The supply voltage must comply with the requirements for safety extra-low voltage (SELV). Cables laid outdoors or outside the control cabinet must be protected accordingly.

### 4.2 Connection of the power supply



### CAUTION!

The low voltage supply must comply with the requirements for safety extra-low voltage (SELV). The supply cable to the safety radar must be protected with a suitable fuse.

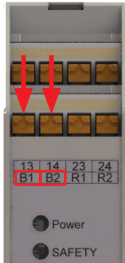

The supply voltage must be connected to terminals B1 and B2. The polarity is arbitrary.

Supply voltage:

Supply voltage:  
10 to 30V DC 5,9W

14 to 26.4V AC 9VA

Connection contacts for the power supply

### 4.3 Sensor connection

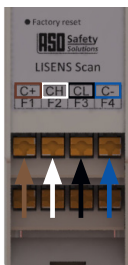

The sensor unit is connected to the control unit via a CAN open safety bus. To do this, connect the short cable with the open wire ends and the M8 socket to the control unit.

Connection C+: brown wire

Connection CH: white wire

Connection CL: black wire

Connection C-: blue wire

The sensor unit is then connected to the control unit via a 2m extension cable.

Connection contacts for the sensor

# LISENS scan

## OPERATING INSTRUCTION

### 4.4 Connecting safety outputs

The radar system has three different safety outputs: a potential-free redundant relay output, an 8k2 simulation and an FSS output that provides a 1kHz square wave signal. On the configuration page of the web server, either FSS or 8k2 can be selected in parallel with the redundant relay output, or one of the outputs alone. The wiring must be adjusted depending on which output is used.





#### WARNING!

Before changing the configuration of the safety outputs, the pin assignment for the safety outputs must be removed. The selected pin assignment of the safety outputs may only be connected after the configuration settings have been made. Incorrect pin assignment of the safety outputs can result in damage to the device.

#### 4.4.1 Relay safety output (observe variant type code)

For the redundant relay output, there are three options for connecting the relay contacts of the control unit to the control system.

In variant 1, the two relays are connected in series, with terminal 14 bridged to terminal 23.	In variant 2, an 8k2 resistor can be used instead of the bridge, so that the device can also be connected to an 8k2 input on the control system.	Variant 3 is for cases where each relay can be connected separately to the control system.
		

#### 4.4.2 FSS safety output (note variant type code)

	<p>The following cables are connected for the FSS option:</p> <ul style="list-style-type: none"><li>Connection F1: brown cable (power or 12V)</li><li>Connection F2: green cable (signal)</li><li>Connection F3: white cable (GND or negative)</li></ul>
---	--

## 4.4.3 Safety output 8k2 – simulation (note variant type code)

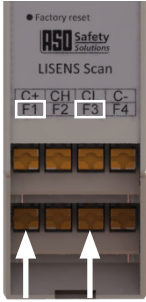
 <p>Factory reset HSO Safety Solutions LISENS Scan</p> <p>C+ CH CI C- F1 F2 F3 F4</p> <p>Connection contacts for a safety output 8k2</p>	<p>For the 8k2 simulation, the following connections are connected to the control system: F1 and F3</p> <p>In the 8k2 simulation, internal switching elements simulate an output resistance value of 8.2 kOhm in the normal state. If a detection occurs in the safety zone, the internal switching elements simulate a resistance of approximately 0 kOhm. In the fault state, the internal switching elements simulate an interruption of the resistance.</p> <p>Safety-related functionality is checked by means of an internal test with a corresponding change in the simulated resistance. The function of the internal test of the safety output depends on the control system used and the design of the input circuitry.</p>
---	---



### Note

It is possible that the safety output is not compatible with specific controllers and that the function of the safety output cannot be guaranteed.

## 4.5 Connection of comfort outputs



### DANGER!

The connection for the comfort outputs is only permitted for switching low voltages. The control circuits must be protected with a suitable fuse depending on the rated current, or the rated current of the control circuits must be limited to the maximum value by other measures.

### 4.5.1 AUX relay safety zone (SZ)

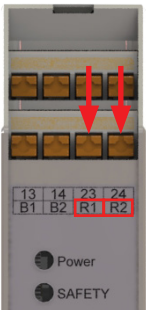
 <p>13 14 23 24 B1 B2 R1 R2</p> <p>Power SAFETY</p> <p>1x connection contact</p>	<p>The SSR for the safety zone is connected to terminals R1 and R2.</p>
--	---

# LISENS scan



## OPERATING INSTRUCTION

### 4.5.2 Relay for comfort zone

 <p>2x connection contacts</p>	<p>The SSR1 is connected to connections F1 and F2. The SSR2 is connected to connections F3 and F4. In this hardware version, outputs FSS and 8k2 are deactivated. The test input is also not available.</p>
---	---

### 4.6 Display functions

Current error messages are displayed. If there are several error messages, they are displayed one after the other with a longer pause in between. If there are no more error messages, the display switches to the normal operating display. If no LED is lit, check the power supply for wiring problems, overvoltage or undervoltage.

 <p>LED1 LED2 LED3</p>	
--	--

LED1: Operating status indicator  
LED2: Safety zone signal status  
LED3: Comfort zone signal status

Power: Operating status indicator  
SAFETY: Safety zone signal status  
COMFORT: Comfort zone signal status

LED 1, 2, 3	Green flashing rapidly	System start, initialisation mode
LED 1 / Power	Green on Normal	Operating status, detection mode
LED 1 / Power	Red on	General error, error status
LED 1 / Power	Red with 2 flash pulses	Safety output test failed, error state
LED 1 / Power	Red with 3 flash pulses	Data transmission between Control Unit and Sensor Unit interrupted
LED 2 / SAFETY	Blue flashing rapidly	Calibration of sensor environment in progress

LED 2 / SAFETY	Green on	The safety zone is not triggered
LED 2 / SAFETY	Red on	The safety zone is triggered or configuration mode is active
LED 2 / SAFETY	Off	Error status; no objects detected in zones
LED 3 / COMFORT	Green on	Comfort zones are not triggered
LED 3 / COMFORT	Red on	Comfort zone 1 is triggered
LED 3 / COMFORT	Red with 2 flashes	Comfort zone 2 is triggered
LED 3 / COMFORT	Red with 3 flashes	Comfort zones 1 and 2 are triggered
LED 3 / COMFORT	Off	Error status; no objects detected in zones
LED 1, 2, 3 / Sensor Unit	Yellow with 3 flashes	Factory reset successful
LED 1 / Sensor Unit	Green flashing rapidly	System start, initialisation mode

## 4.7 „Factory reset“ button

If something has gone wrong and no connection can be established after restarting, press and hold the „Factory reset“ button for approx. 5 seconds while the device remains switched on.  
In order for the „Factory reset“ to be carried out, all sensor units must be connected to the control unit.

To press the „Factory reset“ button, insert a thin object (e.g. paper clip) through the opening in the housing.

The „Factory reset“ resets the factory settings for the WiFi settings and login details (username, password).



„Factory reset“ button on the evaluation unit

## 5 Web-Interface

### 5.1 Connection to WiFi

To start commissioning the LISENS scan, a connection must be established between the mobile device, e.g. laptop/tablet, and the WiFi module of the radar system.

Open the WiFi connection on your device, search for the SSID of the radar system and log in with the password.

SSID: **LISENS-scan-WIFI XXX** (the last three digits of the serial number indicated on the type plate of the control unit)

Password: **ASO-safety-XXXXX** (the last five digits of the serial number indicated on the type plate of the control unit)

Once you have successfully connected to the WiFi, you can use any internet browser to access the URL of the safety radar's web interface.

URL: **radar.asosafety.com**

# LISENS scan

## OPERATING INSTRUCTION



### Note

It may be necessary to disconnect from the internet to ensure that the URL is entered correctly. In addition, you must check that no other device is already connected to the WiFi, as the system can only connect to one device at a time.

It may be necessary to clear the cache if you are still unable to connect to the WiFi.

All VPN connections must be disabled during setup. On iOS devices, the „Limit IP Address Tracking“ function must be deactivated.

## 5.2 Login screen

After entering the URL **radar.asosafety.com** in your internet browser, the login window will appear. To log in to the menu, enter your user name and password in the GUI login window. For the first login, you will find the user name and password on the label on the control unit. You can select English or German as the language.

ASD Safety Solutions

Username  
Enter Username

Password  
Enter Password

Login

English

## 5.3 System information

After successfully logging in, you will see a page with all the information about the software and hardware of all installed components.

The information window can also be accessed via the menu bar by selecting the „System info“ button.

In addition to information about the individual components, any errors that occur are also displayed in the system info.

Menu User English Logout

Page loaded

<b>WiFi Module Info</b> FW version: 1.9.7A Application type: barrier MAC Address: 1C:63:49:70:2F:CD SSID: Klaus-Muster	<b>Evaluation unit info</b> Serial number:  FW version: 1.9.7 Safety Output: Not Defined Revision: REV_A Comfort outputs: Not Defined Barrier configuration: Not Defined Zones configuration: Not Defined Diagnostic Status: OK	<b>Sensor Info</b> Serial number: <b>Not Defined</b> FW version: 1.9.5 Sensor ID: 1 Accelerometer Calibration Status: Yes Environment Teach-In: No Sensor Status: Sensor Online <b>Sensor Config Status:</b> Sensor Configuration Not Sent Diagnostic Status: OK	<b>Sensor Info</b> Serial number: <b>Not Defined</b> FW version: 1.9.5 Sensor ID: 2 Accelerometer Calibration Status: Yes Environment Teach-In: No Sensor Status: Sensor Online <b>Sensor Config Status:</b> Sensor Configuration Not Sent Diagnostic Status: OK
--	---	--	--



**Note**

The sensor information is only visible after the sensors have been programmed. Before that, only the information from the WiFi module and the evaluation unit is displayed.

## 5.4 Menu bar (User)

To configure the system for the first time, click on „Menu“ in the upper left corner. All currently available menu items are listed here, which may vary for different user levels and selected menu items. During the initial configuration, only the information for the evaluation unit and the WIFI module is visible.

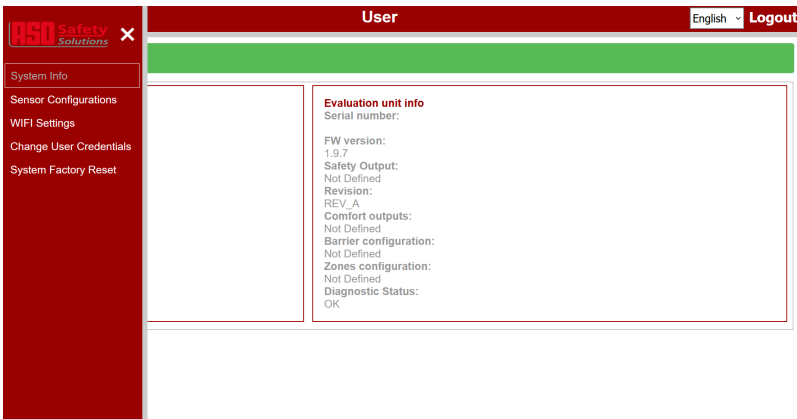

## 5.5 Menu > Configuration

To set up the system and activate the security function, go to the menu bar and select the „Configuration“ option. If you are setting up the device after a factory reset or for the first time, you must first add the sensors before configuration. (See section 2.5.3)

Although all sensors are displayed in the live plot, detected objects can only be displayed by two sensors. The sensors that are to send the object information must be selected using the checkboxes before starting the live image.

Under the „Configuration“ menu item, you can see the current settings of the system. By clicking on the „Start live image“ button, you can then see the selected targets in the live view. You can choose between „Vehicle“, „Other“ and „All targets“.



To access the configuration and set up the sensor(s), press the „Click to start configuration“ button.



When configuration mode is activated, the outputs are switched to the safe state and the display is set accordingly.

Once the sensor and zone settings have been checked for correctness and saved, the configuration menu and the „Exit configuration mode“ button can be selected.



### Note

It is essential that the parameters are saved after they have been entered, otherwise the settings will not be applied. Default values are already displayed during the initial configuration. These can be accepted or changed by saving them. It is nevertheless essential that these values are saved.

A message appears reminding you that teaching is about to begin and that the monitoring area must be clear for teaching. This process takes a few seconds and only occurs if parameters have been added/changed.

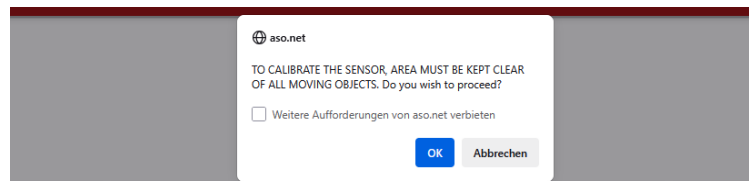

Once calibration is complete, the system returns to operating mode and the switching outputs switch as configured. Depending on the objects detected in the monitored zones, the corresponding outputs are switched and the display LED are set accordingly.



### WARNING!

To check that everything is working correctly, all defined areas must be tested by at least walking along the boundaries and activating the safety zone and comfort zones.

#### 5.5.1 Digital water level

The digital spirit level is used to check how the sensor is installed. It also serves as an acceleration sensor so that it can be monitored whether the position of the sensor has been changed by impact or manipulation.



### WARNING!

After a detected manipulation of the system, it must be reset and restarted. It is essential to check the system again to ensure that it is functioning correctly.

The first step in the configuration is to check the acceleration sensor and to ensure that the sensor is installed correctly. The pitch angle must be 0°. Exception: Potential customer specific version as described in 3.4.3. The roll angle should be 0° if possible.

In addition, the drop-down menu „Select sensor“ can be used to select the sensor whose pitch and roll angle are to be displayed.

## 5.5.2 Configuration of the switching outputs

The safety outputs are configured in „Configuration of outputs“. In addition, it is possible to select various combinations of comfort outputs.

Depending on the hardware variant, the switching output type is defined under „Safety output selection“. At least one safety output must be activated (checkbox selected or drop-down menu selection) in order for the sensor to be configured. The safety output switches as soon as an object activates the safety zone (SZ).

The „Switch-On delay safety output“ option describes the switch-on delay of the safety output after an object has left the zone.



### WARNING!

The preset switch-on delay is 500 ms. Deviating from this value can lead to faulty switching of the safety output.

The „Safety Aux Relay (SZ)“ checkbox activates or deactivates the AUX relay, which switches in parallel with the safety relay. The AUX relay can thus be used, for example, for a courtyard light.

The „Comfort relay 1 (CZ)“ and „Comfort relay 2 (CZ)“ checkboxes activate or deactivate a switching output. Activation occurs when the checkbox is selected (filled). Deactivation occurs when the checkbox is deselected (empty). If a switching output is activated, the dimension of the comfort zone must be configured in section „5.5.5 Configuration of the zone(s)“. If both checkboxes are selected and each is set to a comfort zone, the dimensions of both comfort zones must be configured.

Under „Polarity“, the contact type can be set to „NO“ (Normally Open) or „NC“ (Normally Closed).

Under „Signal Type“, the signal can be set to „Permanent“ or „Pulse“. The pulse duration is 500ms. Under „Object Type“, the objects „Vehicle“, „Other“ or „Both“ can be set.

With the object type „Vehicle“, the outputs only switch when the zone is entered by vehicles such as cars or lorries.

With the object type „Other“, the outputs only switch when an object has not been classified as a vehicle (e.g. person). Vehicles are not detected.

With the object type „Both“, the outputs switch for all detected objects.

Under „Selection of zone“, the switching outputs can be assigned the designation „CZ1“ (comfort zone 1) or „CZ2“ (comfort zone 2).

Under „Movement through zone“, the direction of movement of the object can be set to activate the switching output. The directions are determined from the perspective of the housing in the direction of the barrier arm. If „Inactive“ is selected, the output switches as soon as an object enters the zone.

Menu User English Logout

**Accelerometer started**

**Configuration of outputs**

<b>Safety output selection</b> Safety Relays <input checked="" type="checkbox"/>	Switch-On delay safety output: 500 ms
---	---------------------------------------

<b>Safety Aux Relay (SZ)</b> <input checked="" type="checkbox"/>	<b>Comfort relay 1 (CZ)</b> <input checked="" type="checkbox"/>	<b>Comfort relay 2 (CZ)</b> <input checked="" type="checkbox"/>
Polarity: NO	Polarity: NO	Polarity: NO
Signal Type: Permanent	Signal Type: Permanent	Signal Type: Permanent
Object Type: Both	Object Type: Vehicle	Object Type: Vehicle
Selection of zone:	Selection of zone: CZ1	Selection of zone: CZ1
Moving through zone:	Moving through zone: Left to Right	Moving through zone: Left to Right
Moving through two zones:	Moving through two zones: Inactive	Moving through two zones: Inactive
Object suppression:	Object suppression: Inactive	Object suppression: Inactive

Reload config Save Selection

Under „Movement through two zones“, you can specify whether an object must pass through two zones in order to activate the switching output. If movement through two zones is active, the object must pass through both comfort zones in order for the switching output to be activated.

Under „Zone sequence“, the settings „CZ1 → CZ2“, and „CZ2 → CZ1“ can be selected. This setting defines the sequence that an object must pass through in order to activate the switching output.

The „Object suppression“ setting allows objects in comfort zones to be hidden. This setting is initially inactive and can be activated if necessary.

When this option is activated, objects in the comfort zones are deleted after a certain period of time if they do not move. This can, for example, enable parked vehicles to be hidden. For safety reasons, it is not possible to hide objects within 2m of the safety zone.

To restore the last configured and saved settings, press „Restore configuration“.

To confirm the configuration, press „Save selection“.

An information window appears at the top of the screen. This confirms that the data has been transferred.

### 5.5.3 Configuration of barrier parameters

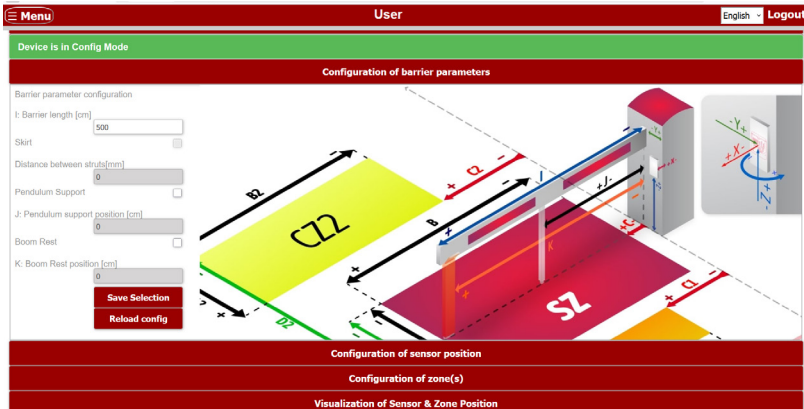

The barrier is defined under the configuration item „Configuration of barrier parameters“.

In addition, you can select whether the barrier system includes pendulum support or boom rest and where these are located.

The length of the barrier must be entered under „I: Barrier length [cm]“.

If the barrier system has a skirt that is longer than 3m, the „Skirt“ checkbox must be activated.

Once the „Skirt“ checkbox is active, the distance between the struts must be specified in the „Distance between struts [mm]“ field.

If the barrier system has a pendulum support, the „Pendulum support position [cm]“ checkbox must be activated.

However, if the „Skirt“ checkbox is selected, the pendulum support cannot be selected.

Once the „Pendulum support“ checkbox is active, the distance of the swing support can be specified in the „J: Pendulum support position [cm]“ field.

If the barrier system has a support post, the „Boom Rest“ checkbox must be activated.

Once the „Boom Rest“ checkbox is active, the distance of the pendulum support can be specified in the „K: Boom Rest position [cm]“ field.

# LISENS scan

## OPERATING INSTRUCTION



### WARNING!

When used on barriers with skirt, two sensors (one on each side) must be used if the product is used as a D accessory in accordance with EN 12453.  
Barriers with boom rest learn their surroundings around the boom rest and can hide objects on the boom rest after 31 seconds.



### Note

The unit for the distance between the struts of the skirt is measured in mm! This refers to the distance from the centre of one strut to the centre of the next.

For barriers with skirt and pendulum supports, only the „Skirt“ function should be selected.

For barriers with skirt and boom rest, both functions should be selected.

For barriers without a skirt, never activate the „Skirt“ function. The availability of the sensor cannot be guaranteed.

To confirm the configuration, press „Save Selection“. An information window appears at the top of the screen. This confirms that the transmission parameters have been transferred.

### 5.5.4 Configuration of sensor position

The screenshot shows the 'Configuration of Sensor(s)' screen in the LISENS interface. The top bar includes 'Menu', 'User', 'English', and 'Logout'. A status bar at the top indicates 'Device is in Config Mode'. The main title is 'Configuration of Sensor(s)'. On the left, there are input fields for sensor position: 'Select sensor' (dropdown with '1'), 'X: Distance from barrier housing [cm]' (input '0'), 'Y: Distance from barrier arm [cm]' (input '0'), 'Z: Distance from ground [cm]' (input '55'), and 'Z Rotation angle [deg]' (input '0'). Below these are 'Common sensor settings' for 'Activation delay for objects' (dropdown 'Standard') and 'Vehicle classification sensitivity' (dropdown 'Standard'). At the bottom are 'Save Selection' and 'Reload config' buttons. On the right, a 3D diagram illustrates the sensor's position relative to the barrier housing and boom, with coordinate axes (X, Y, Z) and rotation angles (alpha, beta, gamma) shown.



### Note

The sensor settings determine the position of the selected sensor unit relative to the zero point. This is located directly on the ground under the barrier boom on the housing.

The following sensor settings must be carried out and saved for all connected sensors one after the other. The sensors are selected using the drop-down menu.

The X distance value describes the distance between the sensor unit and the front of the barrier housing.

The larger the value, the further the sensor unit is from the barrier housing in the direction of the barrier.

The Y distance value describes the lateral distance from the center of the barrier boom to the sensor unit. Looking from the housing in the direction of the barrier boom, the sensor unit is located on the left if the value is positive.

The Z distance value describes the distance from the floor to the sensor unit.

The Z rotation angle value describes the lateral rotation of the sensor unit. A positive value means that the sensor unit is rotated counterclockwise, while a negative value means that the sensor unit is rotated clockwise.

The object classification and detection can be adjusted under the „General sensor settings“ tab. The „Activation delay for objects“ setting adjusts the speed at which non-existent objects are cleared to ensure the agility of the system. The following settings are available: „Standard“, „Fast“, and „Direct“. When Direct is selected, objects are hidden immediately as soon as they are no longer visible to the radar. The other two options have a clear delay.



**WARNING!**

Deviating from the default setting may result in the loss of objects in the detection area.

The „Vehicle classification sensitivity“ option allows you to adjust the sensitivity of vehicle detection. When set to high, objects are classified as vehicles more quickly/easily.

### 5.5.5 Configuration of zone(s)

This configuration menu is used to define the dimensions (length, width, and position) of the safety and comfort zones.



**WARNING!**

A safety zone (SZ) of  $\geq 100\text{cm}$  must always be configured centrally under the barrier.

If the safety zone is placed off-center, there must be at least 50cm of safety zone on each side of the barrier.

The screenshot shows the 'Configuration of Zone(s)' web interface. The interface has a dark red header with 'Menu', 'User', 'English', and 'Logout'. Below the header is a green bar indicating 'Device is in Config Mode'. The main content area is titled 'Configuration of Zone(s)' and contains a form for 'Safety and Comfort zone configuration'. The form includes input fields for Safety Zone (SZ) and Comfort Zone (CZ) dimensions and offsets, and dropdown menus for orientation. The values shown are: A: 100, B: 350, C: 0, D: 0, A1: 200, B1: 350, C1: 0, D1: 0, Orientation: Left, A2: 0, B2: 0, C2: 0, D2: -250, Orientation: Left. At the bottom of the form are 'Reload config' and 'Save Selection' buttons. To the right of the form is a 3D diagram of a barrier with safety and comfort zones, labeled with dimensions A, B, C, and D. The diagram shows a red barrier with a yellow CZ zone and a red SZ zone. Dimensions A and B are along the X-axis, while C and D are along the Y-axis.

The dimensions of the various zones are defined using the following letters:

„A“ defines the width of the zones in the Y direction.

„B“ defines the length of the zones in the X direction.

„C“ defines the offset of the zones from the barrier boom in the X direction.

„D“ defines the offset of the zones from the barrier boom in the Y direction.

A describes the width and B the length of the respective zone.

C and D describe the individual offset of the comfort zone. C indicates the distance to the barrier housing and D the distance to the next zone.

For the safety zone (SZ), the direction of the offset in the X and Y directions is specified by positive or negative values.

For the comfort zones (CZ 1 & CZ 2), however, the alignment is done by selecting „left” or „right” in the drop-down menu. These zones are linked to the position of the safety zone – if the safety zone is moved, the associated comfort zones move automatically with it. The distance to the safety zone is therefore specified in the configuration of the comfort zones.

To confirm the configuration, press „Save Selection”. An info window appears at the top of the screen. This confirms the transfer of the transmission parameters.

### 5.5.6 Display of sensor and zone positions

Here, the currently set configuration data can be viewed as a live image and as a list below without having to reprogram the system.

The objects are not displayed in this menu item, as only the set parameters are to be checked here.

To display the individual sensors and their detection range, they must be activated using the checkbox below. Each sensor is assigned its own color.

These colors mix in the overlap area of two detection ranges. (see illustration below)

The objects are not displayed in this menu item, as only the set parameters are to be checked here.

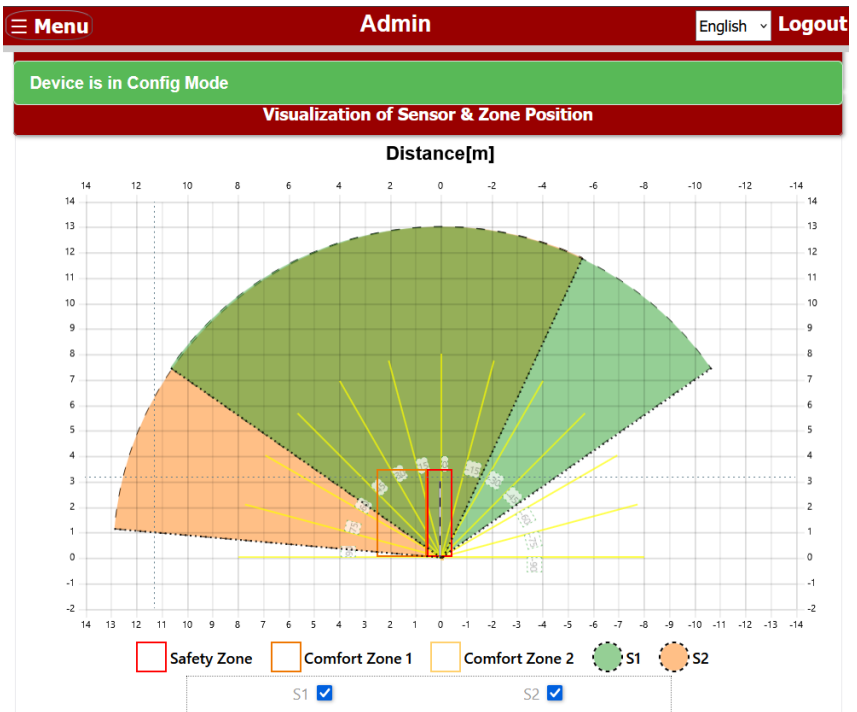

Zone:	Barrier info:	Sensor 1:
A: Safety area width [cm] = 100	I: Barrier length [cm] = 300	X: Distance from the barrier housing [cm] = 0
B: Safety area length [cm] = 350	Skirt = No	Y: Distance from the barrier arm [cm] = 0
C: Safety area offset X [cm] = 0	Distance between struts[mm] = 0	Z: Distance from the ground [cm] = 55
D: Safety area offset Y [cm] = 0	Pendulum = No	Z Rotation angle [deg] = 0
A1: Comfort zone 1 width [cm] = 200	J: Pendulum support position = 0	
B1: Comfort zone 1 length [cm] = 350	Boom rest = No	
C1: Comfort zone 1 offset X [cm] = 0	K: Boom rest position[cm] = 0	
D1: Comfort zone 1 offset Y [cm] = 0		
A2: Comfort zone 2 width [cm] = 0		
B2: Comfort zone 2 length [cm] = 0		
C2: Comfort zone 2 offset X [cm] = 0		
D2: Comfort zone 2 offset Y [cm] = -250		
<b>Sensor 2:</b>		
X: Distance from the barrier housing [cm] = 0		
Y: Distance from the barrier arm [cm] = -10		
Z: Distance from the ground [cm] = 55		
Z Rotation angle [deg] = 30		

## 5.5.7 Firmware update

Here you can perform a firmware update for the control unit or sensor unit. To do this, select the relevant update file and upload the image.



### Note

To run the software update on all sensors, the sensors must have been added individually in advance and must use the same software version. The software versions of the added sensors can be checked on the information screen.

**Firmware Update**

---

**Control Unit Update**

Load image: Choose file  Upload image

---

**Sensor Unit Update**

Load image: Choose file  Upload image



### CAUTION!

The update must not be interrupted under any circumstances, for example by disconnecting the Wi-Fi connection to the device, updating the website, or interrupting the power supply. An interruption can damage or destroy the device.



### CAUTION!

Make sure you are using the correct update file. For example, uploading an update file for the sensors to the control unit can damage or destroy the device.

# LISENS scan

## OPERATING INSTRUCTION

You must confirm the upload via a window. The progress of the update will then be displayed. When the update is complete, the progress bar closes automatically and you can use the device as usual.

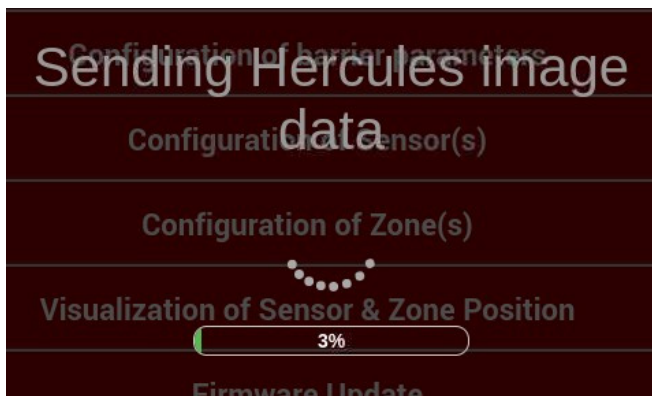

### 5.6 Menu > WiFi settings

In the settings, you can set the SSID and security level yourself and/or change the password. After you have selected the SSID and/or WiFi password, press the „Save SSID” button and the „Save password” button. The device must be turned off and on again for the parameters to take effect and for the new SSID to be displayed in the WiFi connection.

If an error occurs and no connection can be established after restarting, press and hold the „Factory reset” button while the device is switched on

**Menu** **User**

---

**Sensor config**  
Page for Password changing

Page loaded

---

**Change User credentials**

Old Password

New Password

Repeat New Password

**Submit**

## 5.7 Menu > Change user credentials

Here you can set an individual password for logging in. Press the „Save” button to apply the new settings.

If an error occurs and no connection can be established after restarting, press and hold the „Factory reset” button while the device is switched on.

It is strongly recommended that you keep the changed access data in a safe place.

If necessary, the changed access data can be noted on the note pages of this operating manual.

## 5.8 Virtual loops

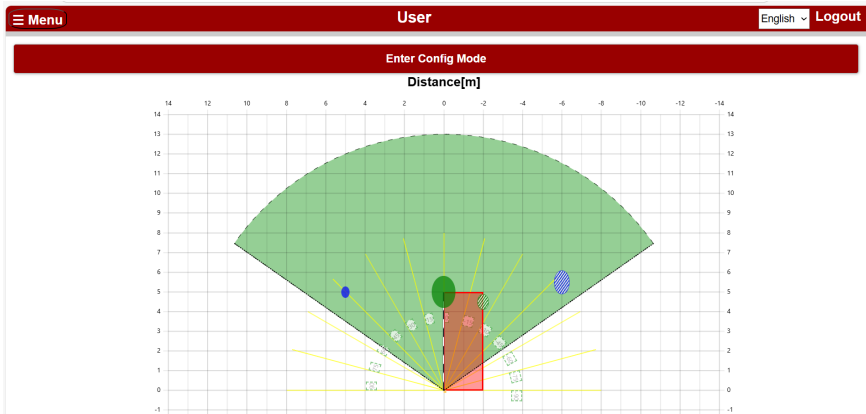

The LISENS scan is capable of projecting virtual loop detectors in the monitored comfort zones. These enable the system to activate direction detection or object detection. Direction detection is set in the „Configuration of switch outputs”. Among other things, this allows an opening request to be reported when the barrier is approached.

### 6 Commissioning and function testing

The following basic aspects must be taken into account when using the LISENS scan:

- Avoid extreme vibrations.
- Do not cover the radar window.
- Avoid moving objects and other radar sources in front of the radar window.
- Avoid condensation.
- Avoid sudden and extreme temperature fluctuations.
- In environments where the temperature may fall below  $-10^{\circ}\text{C}$ , the sensor should be switched on continuously

To start up the LISENS scan for the first time, the system must be switched on and the barrier must be fully open. The area in front of the sensor unit must be empty or at least only contain objects that are constantly in the area during operation.

Please note that permanently present objects obstruct the sensor unit's view of the defined zones, which can lead to dangerous situations.

When the safety radar is used for the first time, no calibration has been performed yet and the device is in its initialization state. Configuration must be carried out via the user interface.

LED 1 / Power	LED 2 / SAFETY	LED 3 / COMFORT
Green on	Red on	Off

If the safety radar is configured, there are no faults and no object is detected in the monitoring field, the idle state is displayed on the Sensor Unit and the Control Unit (all LEDs are green).

#### 6.1 Functionality test

The radar sensor must be checked for proper functioning after commissioning and after changes to the configuration. The test must be documented and stored so that it can be traced at any time. The requirements of the system/machine manufacturer must be taken into account and complied with.

The function of the Comfort version of the radar sensor (D device according to EN 12453) is checked by detecting a human body within the limits of the set zones.

Checking the zones with test object A specified in the EN 12453 standard is not suitable due to the current lack of technical specifications for the test object for the measuring principle of a radar sensor. In this case, it is possible that test body A will be scanned and not detected, even though the radar sensor reliably detects the presence of a real person at all times.

Before the function test can be performed, please ensure that the detection area is free of objects and other obstacles.

To test the function, connect the mobile device to the WiFi and switch to the configuration menu to start the live image. Here you can see the position of the configured zones and the detected objects. Then walk through the virtual zones in reality and compare whether the zones trigger correctly on the mobile device. In addition, the test objects required for the application must be placed in the security zone and detected. This must be checked for all connected sensors.

The functional test must be documented as part of the safety test for the barrier. A repeat test is mandatory after six months at the latest.

Required components:

- 1x test box 200x300x700, alternatively a human body (replacement for test piece A (EN 12453) for use with radar)
- 1x angle reflector 0.17m<sup>2</sup>
- 1x mobile device with Internet browser (e.g., laptop, tablet)

## 7 Error diagnosis and troubleshooting

When the safety radar is started up for the first time, no calibration is available and the device is in the initialization state.

LED 1 / Power	LED 2 / SAFETY	LED 3 / COMFORT
Green on	Red on	Off

If there are no errors in the safety radar and no object is detected in the monitoring field, the sensor unit and control unit display the idle state (all LEDs are green).

The status of the LEDs on the sensor unit and the control unit indicate any existing errors and activated output messages.

LED 1, 2, 3	Green flashing rapidly	System start, initialization mode
LED 1 / Power	Green on	Normal operating state, detection mode
LED 1 / Power	Red on	Error, error state
LED 1 / Power	Red with 2 flash pulses	Safety output test failed, error state
LED 1 / Power	Red with 3 flashes	Data transmission between control unit and sensor unit interrupted
LED 2 / SAFETY	Blue flashing rapidly	Calibration of sensor environment in progress
LED 2 / SAFETY	Green on	The safety zone is not triggered
LED 2 / SAFETY	Red on	The safety zone is triggered or configuration mode is active
LED 2 / SAFETY	Off	Error status; no objects detected in zones
LED 3 / COMFORT	Green on	Comfort zones are not triggered
LED 3 / COMFORT	Red on	Comfort zone 1 is triggered
LED 3 / COMFORT	Red with 2 flashes	Comfort zone 2 is triggered
LED 3 / COMFORT	Red with 3 flashes	Comfort zones 1 and 2 are triggered
LED 3 / COMFORT	Off	Error status; no objects detected in zones
LED 1, 2, 3 / Sensor Unit	Yellow with 3 flashes	Factory reset successful
LED 1 / Sensor Unit	Flashing green rapidly	System startup, initialization mode

# LISENS scan

## OPERATING INSTRUCTION

### 7.1 General errors

Internal error. Perform a factory reset. Contact support. If the device is defective, please replace the system.

### 7.2 Data transmission between Control Unit and Sensor Unit interrupted

Check the cabling between the sensor unit and control unit and/or restart the system. Perform a factory reset. Contact support. If the fault persists, please replace the system.

### 7.3 No objects available

Check the cabling between the sensor unit and control unit and/or restart the system. Perform a factory reset. Contact support. If the fault persists, please replace the system.

### 7.4 Disruption due to environmental influences

The safety radar is very well suited to harsh environments. If environmental influences cause excessive interference, objects may be created that do not exist in the real environment. These objects can cause the outputs to switch.

### 7.5 Mechanical failure

Misalignment due to an accident or vandalism can impair detection capability. Objects may be created that do not exist in the real environment. These objects can cause the outputs to switch.

## 8 Maintenance and servicing

The safety radar does not contain any components that require maintenance by the user.

When cleaning the sensor unit, avoid direct exposure to high-pressure cleaners and the use of aggressive cleaning agents or chemicals. The sensor unit can be cleaned with compressed air or a clean, damp microfiber cloth.

To ensure that the safety system complies with the DIN EN 12453 standard, the system must be checked for correct functioning by qualified personnel at appropriate intervals. The test must be documented in a comprehensible manner at all times. A test is mandatory after six months at the latest.

## 9 Decommissioning and disposal

The products manufactured by ASO are intended exclusively for commercial use (B2B). After the end of use, the products must be disposed of in accordance with all local, regional, and national regulations. ASO will also gladly take back the products and dispose of them properly.

## 10 Technical specifications

### General information

Housing	Sensor: PC and black PUR casting compound Control Unit: PA6.6
Dimensions (HxWxD)	Depending on the mechanical housing
Protection category	Sensor: IP67 according to IEC 60529 Control Unit: IP20 according to IEC 60529
Protection class	III (SELV)
Weight	0.3kg (one sensor and one evaluator, incl. mounting material)
Temperature range	-25 °C to +65 °C
HUmidity	0 to 95%, without condensation
Pollution degree	2

### Radar signal detection

Radar frequency and bandwidth	60-64 GHz / 4 GHz
Azimuth	+/- 60° Tolerance zone, +/- 50° Detection zone
Elevation	+/- 20° Tolerance zone, +/- 15° Detection zone
Distance and speed	Up to 13 meters and maximum speed of 6,79 m/s
Detection capability	Elevation +/- 17° Azimuth up to 9m +/- 57°, up to 13m +/- 50° Distance 13 meters when using angled reflector RCS=0,17m <sup>2</sup>

### Power supply

Operating voltage	10V up to 30V DC / 14V up to 26.4V AC
Current consumption	Approximately 63mA (at 24V DC without a sensor) Approximately 220mA (at 24V DC with one sensor) Approximately 330mA (at 24V DC with two sensors) Each additional sensor increases the current consumption by 100mA.
Power consumption	Approximately 1.51W (at 24V DC without a sensor) Approximately 5.28W (at 24V DC with one sensor) Approximately 7.92W (at 24V DC with two sensors) Each additional sensor increases power consumption by 2.4W.

### Output switching unit

Potential free safety relays	Rated current: 1 A (30V DC), 1 A (26,4V AC) Mechanical lifespan: >106 operations Utilization Category: AC-15 (30V AC; 1A; 800000 Op.), DC-13 (30V DC; 1A; 950000 Op.), 1 sec. switch-on delay
FSS output signal	Pulsed signal, 1kHz, 50% switch-on time, max. 24V 100mA
Output signal 8k2 simulation	quiescent current, max. 5V, with testing
Response time	<=100ms
Comfort relay	500mA at 30V DC
AUX Relais	500mA at 30V DC, potential free

### Other

WIFI-Frequency and bandwidth	2,4 GHz / 200 MHz
------------------------------	-------------------

# LISENS scan

## OPERATING INSTRUCTION

### Safety characteristics

LISENS scan	MTTFD 300 Years, DC >99%, PFHD $2,29 \cdot 10^{-7}$ 1/h
Protective system	„D“-Additional device according to EN 12453

All voltages connected to the safety radar must be safely isolated voltages!

**Protection class III**  
**(Protective insulation)**



# 11 Declaration of conformity

**EG - Konformitätserklärung**  
**EC Declaration of conformity**  
**Déclaration de conformité CE**



Hiermit erklären wir, dass die nachfolgend bezeichneten Produkte der Baureihe

**LISENS scan CA-B-Set 1**  
**LISENS scan CUC2-2BA**  
**LISENS scan CUC2-2BC1**  
**LISENS scan SUC1-1240E**  
**LISENS scan SUC2-1240E**  
**LISENS scan CC1-B-Set 1**  
**LISENS scan SUC3-1240E Erw.-Set A**  
**LISENS scan CUC2-2BA**  
**LISENS scan SUC2-1240E Erw.-Set A**  
**LISENS scan CA-B-Set 2**  
**LISENS scan CC1-B-Set 2**

aufgrund ihrer Konzipierung und Bauart sowie in der von uns in Verkehr gebrachten Ausführung, den einschlägigen grundlegenden Sicherheits- und Gesundheitsanforderungen der nachfolgenden EG-Richtlinien und Normen entsprechen:

**2006/42/EG**  
**EN 12453\***  
**2014/53/EU - RED**  
**2011/65/EU; 2015/863/EU - RoHS**  
**(EG) Nr. 1907/2006 - REACH**

\*nur „D“-Zusatzeinrichtung  
(Anwesenheitserkennung, Ersatz Lichtschranke)

Alle technischen Daten für diese Produkte werden sicher aufbewahrt und werden erforderlichenfalls der behördlichen Marktaufsicht auf Anfrage zur Verfügung gestellt.

Diese Konformitätserklärung entbindet den Konstrukteur/ Hersteller der Maschine nicht von seiner Pflicht, die Konformität der gesamten Maschine, an der dieses Produkt angebracht wird, entsprechend der EG-Maschinen-richtlinie sicherzustellen.

**Hersteller und**  
**Dokumentationsbevollmächtigter**

**ASO GmbH**  
Hansastr. 52  
D-59557 Lippstadt  
Lippstadt, 05.05.2025

We hereby declare that the following products of the model range

**LISENS scan CA-B-Set 1**  
**LISENS scan CUC2-2BA**  
**LISENS scan CUC2-2BC1**  
**LISENS scan SUC1-1240E**  
**LISENS scan SUC2-1240E**  
**LISENS scan CC1-B-Set 1**  
**LISENS scan SUC3-1240E Erw.-Set A**  
**LISENS scan CUC2-2BA**  
**LISENS scan SUC2-1240E Erw.-Set A**  
**LISENS scan CA-B-Set 2**  
**LISENS scan CC1-B-Set 2**

satisfy the relevant essential health and safety requirements of the EC directives and standards listed below on account of its design and construction, as does the version brought to market by us:

**2006/42/EG**  
**EN 12453\***  
**2014/53/EU - RED**  
**2011/65/EU; 2015/863/EU - RoHS**  
**(EG) Nr. 1907/2006 - REACH**

\*only "D"-Device (Presence detection, light barrier replacement)

All technical data for these products are securely stored and, if necessary, made available to regulatory market surveillance upon request.

This declaration of conformity does not relieve the designer / manufacturer of the machine from his obligation to ensure that the conformity of the entire machine to which this product is attached satisfies the corresponding EC directive.

**Manufacturer and attorney of documents**

H. Friedrich  
- Geschäftsführer - CEO - Gérant -

Par la présente nous déclarons que les produits suivants de la série

**LISENS scan CA-B-Set 1**  
**LISENS scan CUC2-2BA**  
**LISENS scan CUC2-2BC1**  
**LISENS scan SUC1-1240E**  
**LISENS scan SUC2-1240E**  
**LISENS scan CC1-B-Set 1**  
**LISENS scan SUC3-1240E Erw.-Set A**  
**LISENS scan CUC2-2BA**  
**LISENS scan SUC2-1240E Erw.-Set A**  
**LISENS scan CA-B-Set 2**  
**LISENS scan CC1-B-Set 2**

de par sa conception et sa construction, ainsi que dans les modèles mis en circulation par nos soins, répondent aux exigences de base pour la sécurité et la santé des directives et normes CE suivantes:

**2006/42/EG**  
**EN 12453\***  
**2014/53/EU - RED**  
**2011/65/EU; 2015/863/EU - RoHS**  
**(EG) Nr. 1907/2006 - REACH**

\* dispositif additionnel « D » seulement  
(Détection de présence, remplacement de la barrière lumineuse)

Toutes les données techniques relatives à ces produits seront conservées en toute sécurité et, seront mises, sur demande, à la disposition des autorités de réglementation.

Cette déclaration de conformité ne délie pas le constructeur / fabricant de la machine de son obligation d'assurer la conformité de l'ensemble de la machine à laquelle ce produit est apposé selon la directive CE.

**Fabricant et agent de documentation**



### 12 FAQ

Trouble	Actions
No WIFI appears for a connection.	<p>Wait about 30 seconds after switching on so that the detected WIFI networks are updated.</p> <p>Update the displayed networks on your end device.</p> <p>Switch the radar sensor off and then on again after 5 seconds.</p> <p>Carry out a „Factory Reset“.</p> <p>If the problem persists, call support.</p>
The WIFI connection cannot be established.	<p>Check that the user name and password entered are correct.</p> <p>Make sure that no other devices are connected to the network.</p> <p>Carry out a „Factory Reset“.</p> <p>If the problem persists, call support.</p>
The connection to the domain cannot be established (login).	<p>Check whether the correct domain address has been entered.</p> <p>Check whether a sufficient connection to the radar sensor has been established.</p> <p>Clear the cache of your browser.</p> <p>Make sure that you are not using a VPN (this includes Apple’s Private Relay service).</p> <p>For IOS devices, set the „limit up address tracking“ setting to Off.</p> <p>Switch off mobile data so that no DNS is executed via the Internet.</p> <p>If the problem persists, call support.</p>
The radar system sees objects even though they do not exist.	<p>Check the configuration settings. Ensure that the sensor position has been set correctly. Calibrate the device again.</p> <p>If the problem persists, call support</p>
A person is recognized as a vehicle in a zone.	<p>It is normal behavior for the radar sensor to detect a large reflective surface for an object. No action is required.</p> <p>This effect can occur when a person is standing close to an object in the detection range or when several people are standing close together.</p> <p>If the radar sensor detects an object as a vehicle, it will always remain a vehicle even if the reflective surface subsequently becomes smaller.</p>
A vehicle is not classified as a vehicle.	<p>The alignment of the sensor and the surroundings (e.g., barrier with curtain) influence object classification. Object classification works best when the sensor is aligned so that objects, e.g., vehicles, approach the sensor. The sensor is therefore not aligned parallel to the barrier. Furthermore, the sensitivity of the vehicle detection can be set to „high.“</p> <p>Solution 1: Set vehicle detection sensitivity to „high.“</p> <p>Solution 2: Rotate the sensor.</p> <p>Solution 3: Set object classification to „Both.“</p>
After the factory reset, it is not possible to log into the device.	<p>The device must be turned off and on again. If the error persists, repeat the factory reset.</p>
The factory reset cannot be performed.	<p>The sensor unit is not connected or is not connected properly.</p>

The objects on the GUI are displayed too small and are not legible.

Use a device with a larger screen. When using smartphones, zooming in on the live image may be faulty or may not work, depending on the software version. In this case, use a tablet or laptop.

The sensor takes too long to reactivate the area.

Reduce the switching delay of the output. Adjust the size of the zones.

The sensor takes too long to reactivate the area.

Reduce the release delay for objects.

# LISENS scan

## OPERATING INSTRUCTION

### 13 Notes on WIFI connection and login

The changed access data for the WiFi connection can be entered here so that registration for a service is subsequently possible.

Connection WIFI

SSID	LISENS-scan-WIFIXXX XXX (XXX= last <b>three</b> digits of the ASO serial number)
Password	ASO-safety-XXXXX (XXXXX= last <b>five</b> digits of the ASO serial number)

User login

Username	User
Password	LISENS-scan

Connection WIFI

SSID	
Password	

User login

Username	
Password	

Connection WIFI

SSID	
Password	

User login

Username	
Password	

## Notes on parameter settings

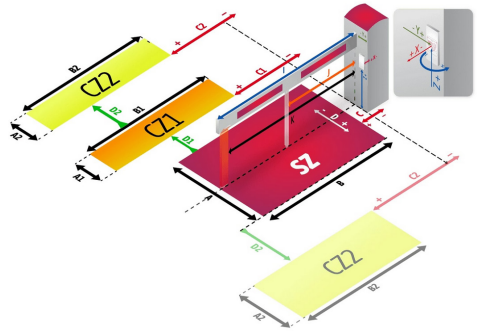

### Zone-Info:

A: Safety area width [cm]	
B: Safety area length [cm]	
C: Comfort area offset X [cm]	
D: Comfort zone offset Y [cm]	
A1: Comfort zone 1 width [cm]	
B1: Comfort zone 1 length [cm]	
C1: Comfort zone 1 offset X [cm]	
D1: Comfort zone 1 offset Y [cm]	
Comfort zone 1 orientation	
A2: Comfort zone 2 width [cm]	
B2: Comfort zone 2 length [cm]	
C2: Comfort zone 2 offset X [cm]	
D2: Comfort zone 2 offset Y [cm]	
Comfort zone 2 orientation	

### Barrier-Info:

I: Length length [cm]	
Skirt	
Distance between struts [mm]	
Pendulum	
J: Pendulum support position	
Boom rest	
K: Boom rest position [cm]	

# LISENS scan

## OPERATING INSTRUCTION

Sensor 1	
X: Distance from the barrier hausing [cm]	
Y: Distance from the barrier arm [cm]	
Z: Distance from the ground [cm]	
Z Rotation angle [deg]	

Sensor 2	
X: Distance from the barrier hausing [cm]	
Y: Distance from the barrier arm [cm]	
Z: Distance from the ground [cm]	
Z Rotation angle [deg]	

Sensor 3	
X: Distance from the barrier hausing [cm]	
Y: Distance from the barrier arm [cm]	
Z: Distance from the ground [cm]	
Z Rotation angle [deg]	

Sensor 4	
X: Distance from the barrier hausing [cm]	
Y: Distance from the barrier arm [cm]	
Z: Distance from the ground [cm]	
Z Rotation angle [deg]	

Sensor 5	
X: Distance from the barrier hausing [cm]	
Y: Distance from the barrier arm [cm]	
Z: Distance from the ground [cm]	
Z Rotation angle [deg]	

Sensor 6	
X: Distance from the barrier hausing [cm]	
Y: Distance from the barrier arm [cm]	
Z: Distance from the ground [cm]	
Z Rotation angle [deg]	







## ENGLISH

DOC0001658 Operating instructions Rev 06

Subject to technical changes.

No liability can be accepted for errors and misprints.



**ASO GmbH** Antriebs- und Steuerungstechnik  
Hansastraße 52 ▪ 59557 Lippstadt ▪ GERMANY  
T: +49 2941 9793-0 ▪ F: +49 2941 9793 299  
www.asosafety.de ▪ E-Mail: aso-eu@asosafety.com



[https://www.asosafety.co.uk/fileadmin/user\\_upload/downloads/pdfs/produkte/Operating\\_Manual\\_ASO\\_Radar\\_Sensor\\_01.pdf](https://www.asosafety.co.uk/fileadmin/user_upload/downloads/pdfs/produkte/Operating_Manual_ASO_Radar_Sensor_01.pdf)